



**Features**

- 2-way, self-powered, bi-amplified loudspeaker
- New digital filters eliminate transient smear and horn “honk”
- Rugged, Baltic birch plywood enclosure
- Extremely high output-to-weight ratio
- Symmetrical shape allows mirror-image stage monitoring

**Description**

The NT Series are self-powered, bi-amplified loudspeakers. Designed for the demands of professional use, they can be the main PA or stage monitors in both portable and installed applications, including: theatres, corporate AV, clubs, houses of worship, schools, auditoriums, and band gigs.

Powerful, field-replaceable, amplifier modules use proven, high efficiency technology. Adding only about 9 lb (4 kg) per loudspeaker, these dependable amplifiers not only provide lots of power, their design affords superior sonic performance.

NT’s digital signal processing sets it apart. EAW invented new, digital filter algorithms, called Guinness Focusing™, to generate precise, complex, filter responses. These filters provide the linear phase response needed for transient accuracy while eliminating coloration from internal phase plug and horn mouth reflections. Digital limiting, specifically tailored to driver limitations and to maintain sound quality, provides more usable output while reducing the risk of driver damage. EAW’s new processing results in a powerful, horn-loaded loudspeaker that has the natural, open, detailed reproduction of the best direct radiating designs.

NT’s mechanical performance received equal attention, including many weight-saving design elements, while maintaining the traditional, rugged, dependability of EAW loudspeakers.

The companion, self-powered NTS22 subwoofer is engineered to extend the low frequency response and output capabilities of NT full-range loudspeakers. Its integral low pass filter provides an optimized, acoustic crossover between the full-range and subwoofer.

Six year loudspeaker warranty. Two year electronics warranty.

1 Specified performance is with the fixed, integral, signal processing. Performance will vary with any external signal processing.  
 2 Input signal: pink noise, 20 Hz to 20 kHz, 6 dB crest factor.  
 3 Input ac volt ranges as specified to meet Compliances. Maximum ranges: 115 V = 90 V to 132.5 V; 230 V = 190 V to 265 V.

**2-WAY SELF-POWERED, 90° x 45°**

See NOTES TABULAR DATA for details

**CONFIGURATION**

Subsystem		
	Transducer	Loading
LF	1x 12 in, 3 in voice coil cone driver with neodymium Orbital Magnet Array™	Sealed
HF	1x 1.4 in exit, 3 in voice coil compression driver with neodymium Orbital Magnet Array™	Horn-loaded

Operating Mode		
	Amplifier Channels	Signal Processing
Bi-amp	LF, HF	DSP w/2-way filters

**ACOUSTICAL PERFORMANCE 1**

Operating Range	60 Hz to 20 kHz	
Nominal Beamwidth	Horz	90°
	Vert	45°

Axial Output Limit (whole space SPL)		
	Average	Peak
Calculated LF/HF	127 dB	133 dB

**ELECTRICAL PERFORMANCE**

Input		
	Type	Electronically balanced
Sensitivity	2.5 V / 10 dBu at Limit <sup>2</sup>	6.2 V / 18 dBu at Clip <sup>2</sup>
Impedance	20 k ohm (balanced to chassis), 10 k ohm (unbalanced)	
Wiring	Pin 1: chassis, Pin 2: signal +, Pin 3: signal -	

DSP (50 Mflop 32 bit Sharc)		
	Encoding	Filters
	24 Bit / 48 kHz	Proprietary
	Latency 2.15 ms	

Amplifier		
	LF	HF
Type	Modified Class D	Modified Class D
Maximum Output	63 V, 1000 W @ 4 ohm	45 V, 500 W @ 4 ohm
THD + noise	<0.3 %	<0.1 %
Dynamic Range	>105 dB	>102 dB
Driver Protection	Integral DSP limiting	

AC Mains (Nominal)		
	115 V	230 V
Connector	Neutrik PowerCon®	
Input	100 V to 120 V <sup>3</sup>	220 V to 240 V <sup>3</sup>
Frequency	50 Hz to 60 Hz	50 Hz to 60 Hz
Current:	Idle	0.25 A
	In Rush	0.9 A
Output Limit	1.6 A <sup>2</sup>	1.0 A <sup>2</sup>
Fuse Rating	10A	6.3A

CONTROLS		
	HPF (crossover)	Mode
	55 Hz / 110 Hz	Normal / Coupled

INDICATORS (LED)		
	Signal Present	Green
	Limiters Active	Yellow
	Clip	Red
	Amplifier Status	Green (Normal), Red ( Fault)

ORDERING DATA		
Description	Part Number	
NT29 2-Way Self-powered Black 115 V	0015146	
NT29 2-Way Self-powered Black 230 V	0016280	
<b>Optional Accessories</b>		
Fly Clip with ring	0001386	

COMPLIANCE		
	CE	EN 60065:2002, EN 55103-1:1997, EN 55103-2:1997, EN55103-1, EN55103-2, EN60065
	CSA	CAN/CSA 60065-03, UL Std No. 60065-03
	FCC	Part 15



## ENCLOSURE

Material	Baltic birch plywood, aluminum back panels, Santoprene™ bumpers
Finish	Wear resistant textured black paint
Grille	Powder-coated perforated steel

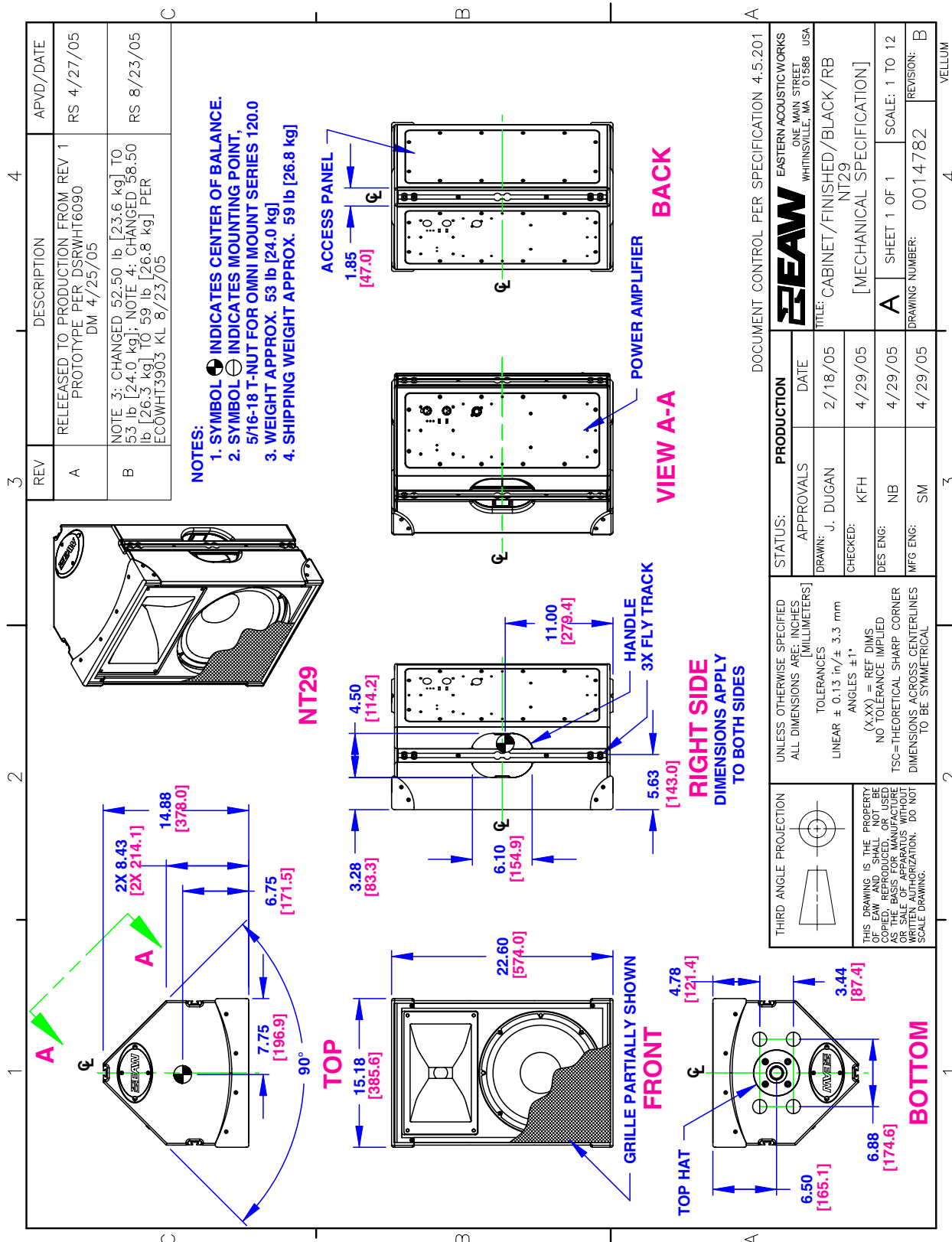

NOTE: This drawing has been reduced. Do not scale.

**PERFORMANCE DATA**

See *NOTES GRAPHIC DATA* for details

**Frequency Response: Processed Bi-amplified**

Complete = blue

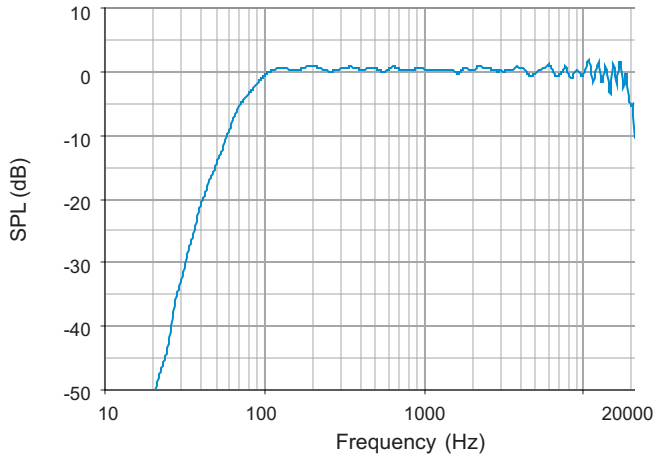

**Phase Linearity**

Complete = blue

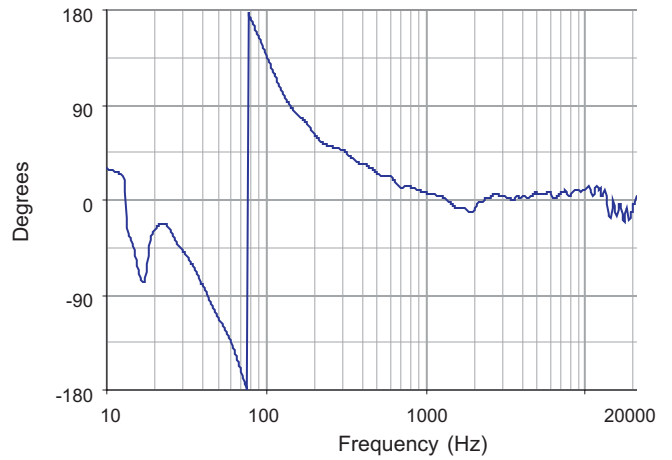

**Beamwidth (-6 dB SPL Points)**

Horizontal = orange Vertical = black

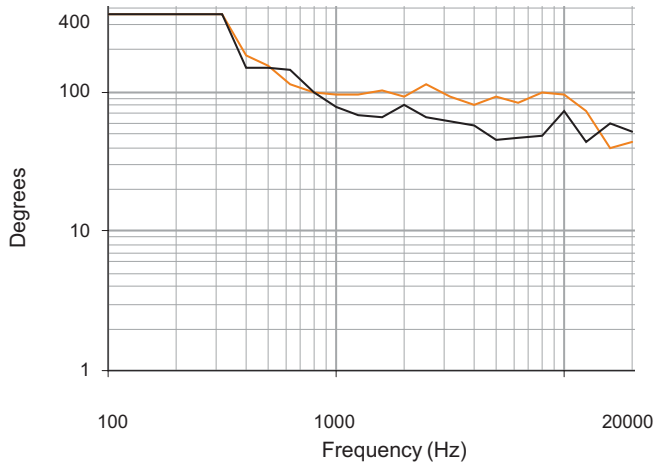

**Directivity (DI, Q)**

Complete = blue

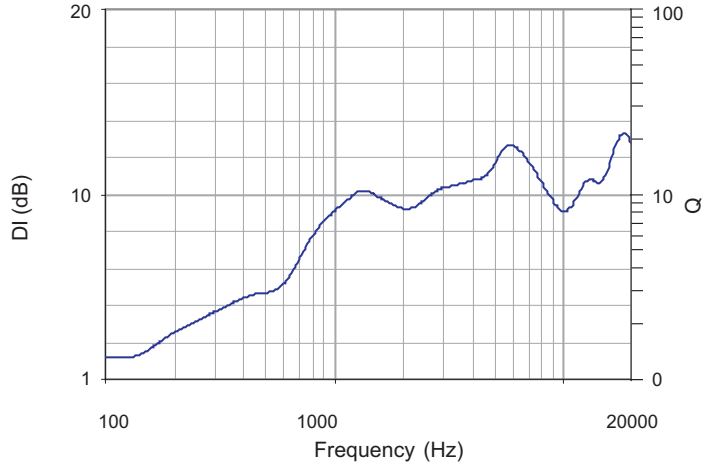

**HORIZONTAL POLAR DATA** (Gridlines: 6 dB axial / 15 degree radial)

See **NOTES GRAPHIC DATA** for details

100 Hz  
125 Hz  
160 Hz  
200 Hz

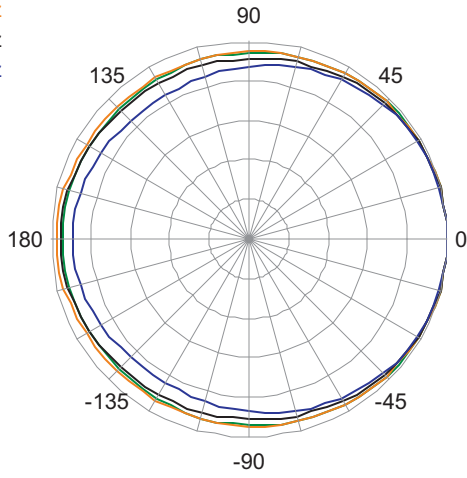

1600 Hz  
2000 Hz  
2500 Hz  
3150 Hz

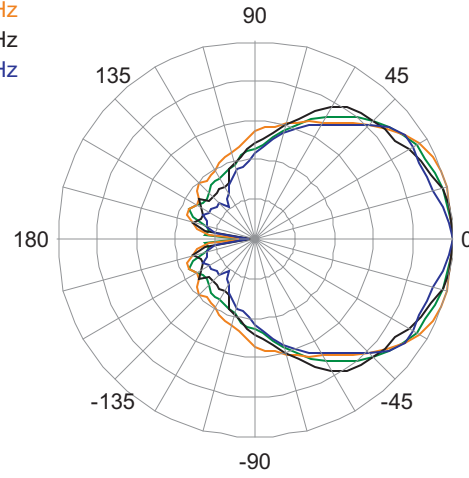

250 Hz  
315 Hz  
400 Hz  
500 Hz

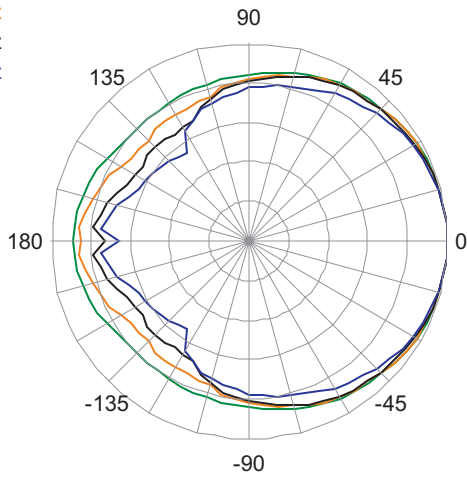

4000 Hz  
5000 Hz  
6300 Hz  
8000 Hz

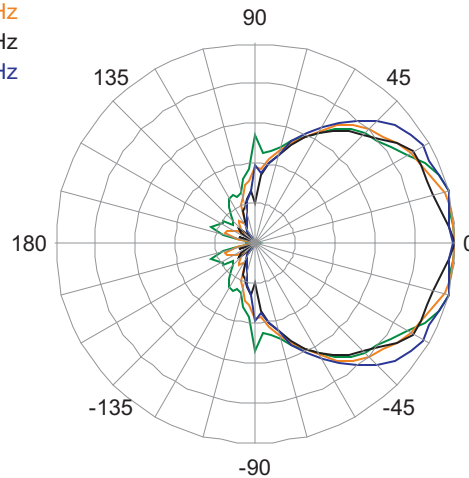

630 Hz  
800 Hz  
1000 Hz  
1250 Hz

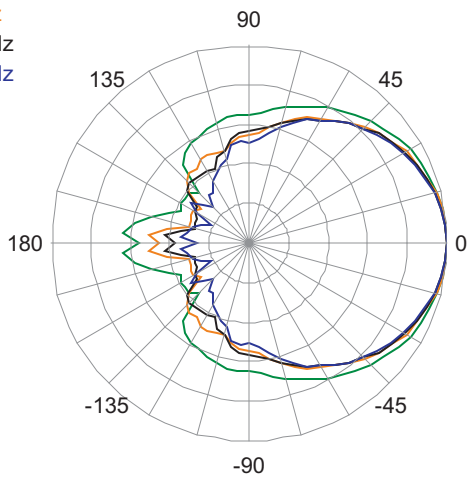

10000 Hz  
12000 Hz  
16000 Hz

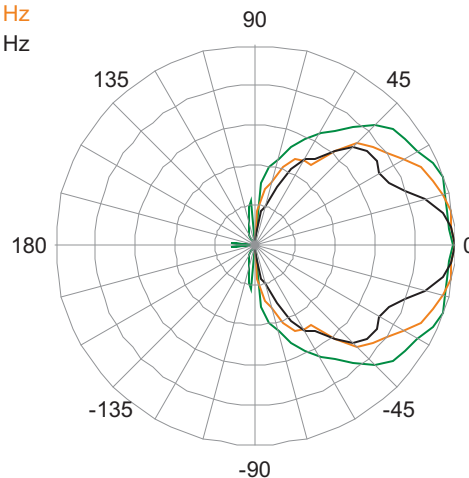

## VERTICAL POLAR DATA (Gridlines: 6 dB axial / 15 degree radial)

See **NOTES GRAPHIC DATA** for details

100 Hz  
125 Hz  
160 Hz  
200 Hz

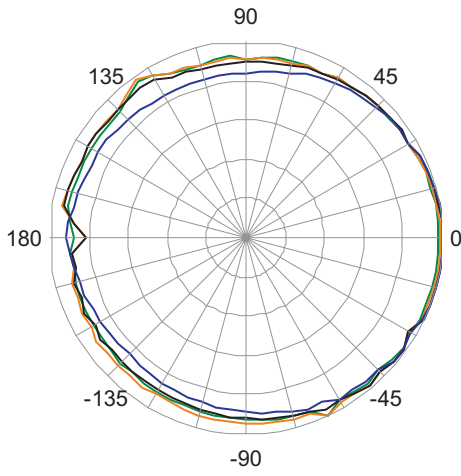

1600 Hz  
2000 Hz  
2500 Hz  
3150 Hz

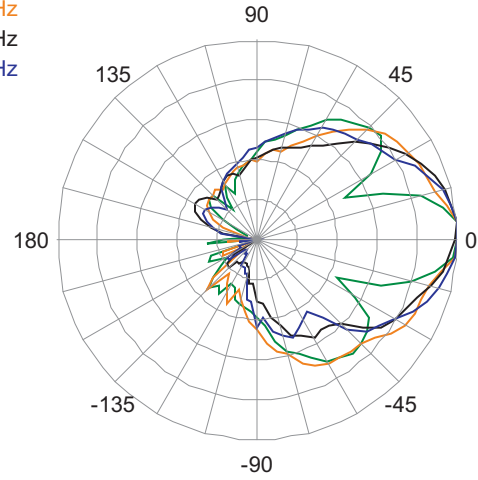

250 Hz  
315 Hz  
400 Hz  
500 Hz

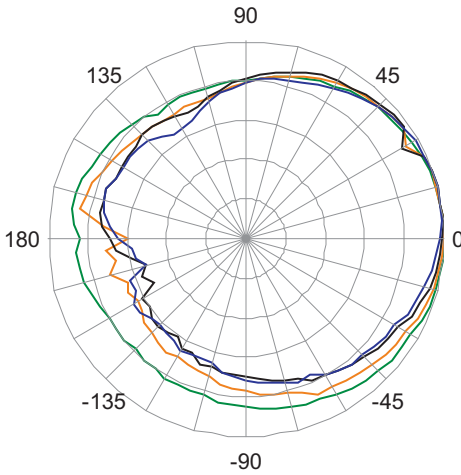

4000 Hz  
5000 Hz  
6300 Hz  
8000 Hz

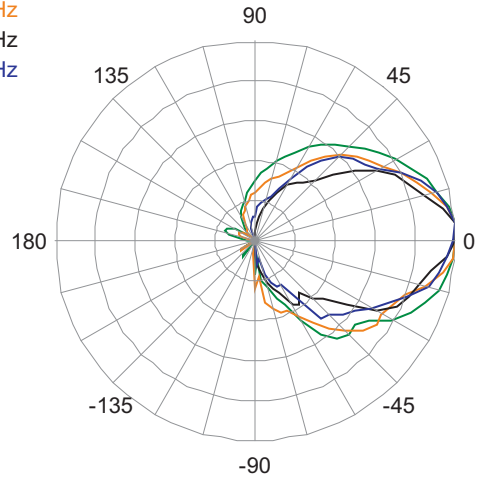

630 Hz  
800 Hz  
1000 Hz  
1250 Hz

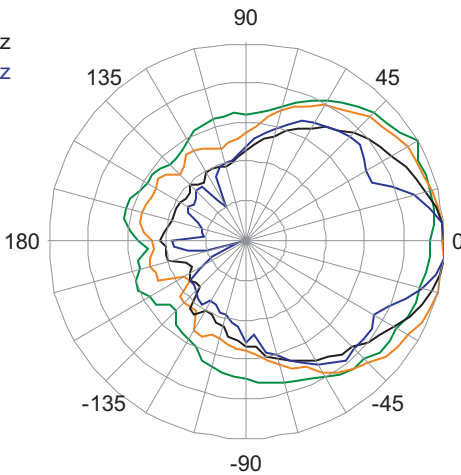

10000 Hz  
12000 Hz  
16000 Hz

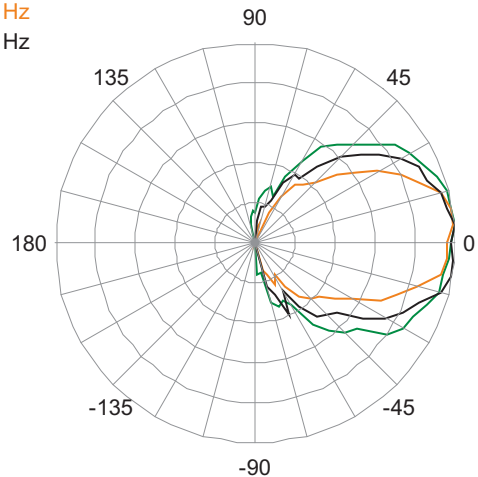

INPUT PANEL

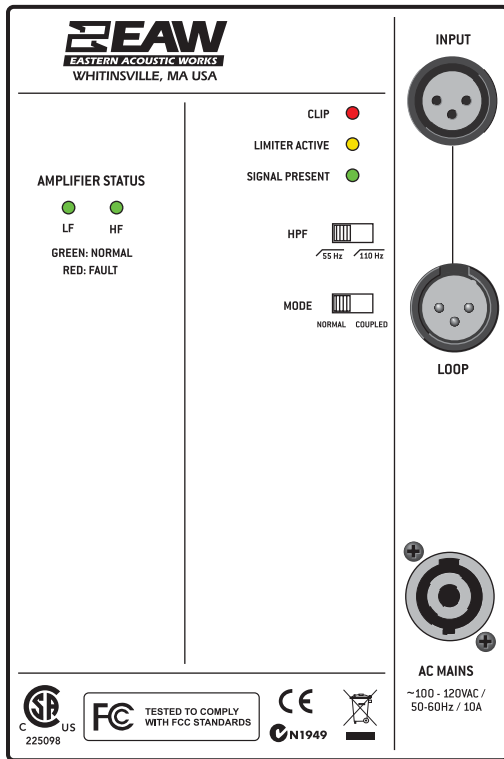

SIGNAL DIAGRAM

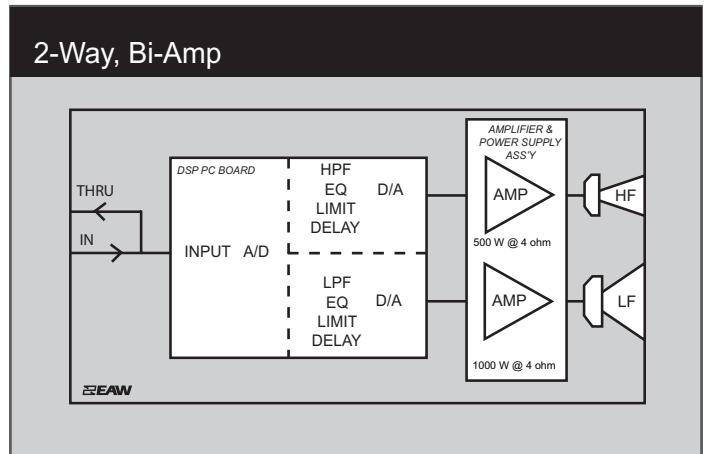

LEGEND

- DSP/EQ:** Integral Digital Signal Processing.
- HPF:** High Pass Filter for crossover.
- LPF:** Low Pass Filter for crossover.
- LIMIT:** Driver and Electronic Protection.
- LF/MF/HF:** Low Frequency / Mid Frequency / High Frequency.
- AMP:** Power Amplifier.

NOTES

TABULAR DATA

1. **Measurement/Data Processing Systems:** Primary - FChart: proprietary EAW software; Secondary - Brüel & Kjær 2012.
2. **Microphone Systems:** Earthworks M30; Brüel & Kjær 4133
3. **Measurements:** Dual channel FFT; length: 32 768 samples; sample rate: 48 kHz; logarithmic sine wave sweep.
4. **Measurement System Qualification** (includes all uncertainties): SPL: accuracy +/-0.2 dB @ 1 kHz, precision +/-0.5 dB 20 Hz to 20 kHz, resolution 0.05 dB; Frequency: accuracy +/-1 %, precision +/-0.1 Hz, resolution the larger of 1.5 Hz or 1/48 octave; Time: accuracy +/-10.4 µs, precision +/-0.5 µs, resolution 10.4 µs; Angular: accuracy +/-1°, precision +/-0.5°, resolution 0.5°.
5. **Environment:** Measurements time-windowed and processed to eliminate room effects, approximating an anechoic environment. Data processed as anechoic or fractional space, as noted.
6. **Measurement Distance:** 7.46 m. Acoustic responses represent complex summation of the subsystems at 20 m. SPL is referenced to other distances using the Inverse Square Law.
7. **Enclosure Orientation:** For beamwidth and polar specifications, as shown in Mechanical Specification drawing.
8. **Volts/Amperes:** Measured rms value of the signal or as noted.
9. **Watts:** Per audio industry practice, "loudspeaker watts" are calculated as voltage squared divided by rated nominal impedance. Thus, these are not True Watt units of energy as defined by International Standard.
10. **SPL:** (Sound Pressure Level) Equivalent to the average level of a signal referenced to 0 dB SPL = 20 microPascals.
11. **Subsystem:** This lists the transducer(s) and their acoustic loading for each passband. Sub = Subwoofer, LF = Low Frequency, MF = Mid Frequency, HF = High Frequency.
12. **Operating Mode:** Between system elements, a comma (,) = separate amplifier channels; a slash (/) = single amplifier channel. DSP = Digital Signal Processor.
13. **Operating Range:** Range where the processed Frequency Response stays within -10 dB SPL of the power averaged SPL within this range; measured on the geometric axis. Narrow band dips are excepted.
14. **Nominal Beamwidth:** Design angle for the -6 dB SPL points, referenced to 0 dB SPL as the highest level.
15. **Measured Axial Output Limit:** SPL for Pink Noise and an average of musical selections at the Limit and Clip thresholds; measured on the geometric axis, referenced to 1 m.
16. **Electrical Performance:** Input, DSP (Digital Signal Processing), amplifier, and ac mains characteristics.
17. **Controls:** Functions that can be adjusted by the operator.
18. **Indicators:** Operating status indicators.

GRAPHIC DATA

1. **Resolution:** To remove insignificant fine details, 1/12 octave cepstral smoothing was applied to acoustic frequency responses and 1/3 octave cepstral smoothing was applied to the beamwidth and directivity data. Other graphs are plotted using raw data.
2. **Frequency Response:** Variation in acoustic output level with frequency for a constant input signal. normalized to 0 dB SPL.
3. **Phase Linearity:** The difference in phase between the input signal and acoustic output, with signal processing latency removed.
4. **Beamwidth:** Average angle for each 1/3 octave frequency band where, starting from the rear of the loudspeaker, the output first reaches -6 dB SPL referenced to 0 dB SPL as the highest level. This method means the output may drop below -6 dB SPL within the beamwidth angle.
6. **Directivity:** Directivity Index (DI) and Directivity Factor (Q).
5. **Polar Data:** Horizontal and vertical polar responses for each 1/3 octave frequency band 100 Hz to 16 kHz or Operating Range.

NT TECHNOLOGY

**NT Design Challenges:** The goal for NT loudspeakers was to provide the pristine, transient performance, smooth frequency response, and lack of coloration of direct radiating studio monitors while providing the powerful, high output needed for professional PA applications. This meant horn-loading was required for output capability. However, inherent to horns are two, un-studio-like, but well-known problems: transient smearing or “splashiness” and honk. These problems are caused by internal reflections within the horn and phase plug. Figure 1 shows the spectrogram of an ideal, point-source loudspeaker. Figures 2 and 3 show the spectrograms of an NT loudspeaker optimized with conventional digital signal processing (DSP).

In Figure 2 the spectrogram is set to show some vertical lines in the highest two octaves. These are internal reflections being emitted from the phase plug after the initial signal. These cause splashy-sounding transients, significantly reducing “crispness” and high frequency detail. This also causes transient information to be masked by the reflections from previous signals. Correcting this by phase plug redesign would significantly degrade efficiency, bandwidth, and frequency response flatness.

In Figure 3 the spectrogram is set to show broader, vertical spikes of sound reflecting from the mouth back into, then back out of the horn. The period of these repeated spikes corresponds to the frequency of the prominent, green, horizontal lobe. This lobe shows in-phase summation of the original signal and these subsequent reflections. All this causes the familiar “honk” in horns, the amount varying with a horn’s specific geometry and beamwidths. Both transient splashiness and honk problems are sometimes assumed to be non-minimum phase phenomena and uncorrectable. NT proves these assumptions are incorrect.

**Gunness Focusing™** : Using innovative analysis tools and methods developed by EAW, the specific parameters of these problems were isolated and analyzed as to the solutions using DSP. However, the desired complex filter responses required accuracies grossly lacking in conventional DSP filters based on the Bilinear Z Transform (BZT). These filters sacrifice response accuracies in the upper audible octaves to avoid mathematical difficulties involving the Nyquist frequency. This results in filter response magnitude errors of over 15 dB, with equally flawed phase performance. Using FIR (Finite Impulse Response) filters would have resulted in latencies in excess of acceptability for real time use. Gunness Focusing avoids these issues while employing the exact, complex, filter responses required.

The results of applying Gunness Focusing to an NT loudspeaker are shown in Figure 4. Both time smear and “honk” are largely gone, making NT’s spectrogram look quite similar to the ideal in Figure 1. NT’s exceptional frequency and phase responses can be seen in the Performance Data. The change in phase below about 300 Hz simply reflects the overall high pass characteristic of the loudspeaker.

**Amplification:** NT’s amplifiers are designed specifically for real audio signals by using advanced, intelligent, power supply control to provide superior audio quality, extraordinary efficiency, cool operation, and invariance to ac mains disturbances. Circuit protection includes separate power supply and amplifier thermal protection, HF and overall amplifier overload, and a two-state, over-current limiter. The protection circuits are self-resetting, minimizing audio down-time.

**Weight:** As with any portable loudspeaker, particularly with integral electronics, the engineering challenge was eliminating all possible sources of excess weight without compromising EAW’s heritage of exceptionally strong and acoustically inert enclosures. To this end, EAW engineered NT like a finely tuned racecar, where a high efficiency engine, aluminum flywheel, unique chassis design, drilled foot pedals, and the like reduce weight, while maintaining strength, and improving performance. Among NT’s weight-saving design elements are: unique joinery to eliminate interior cleats; fly-cutting excess wood, where the full thickness is not needed; removal of unneeded grille railing; structural aluminum fly tracks that also serve as handles; and unique, neodymium, Orbital Magnet Arrays™ to reduce driver magnet weight. The electronic design is so efficient, the entire electronics package (including DSP, heat sinks, connectors, etc.) for the full-range 1500 W power plant, as well as for the 2000 W subwoofer power plant, weighs only 9 lb / 4.1 kg!

The result of this attention to detail is that NT loudspeakers approach the weight of popular, plastic enclosure, self-powered loudspeakers. However, NT loudspeakers provide the robust, physical and acoustical performance of Baltic birch plywood enclosures and a lot more amplifier power.

**Dependability:** NT loudspeakers are bi-amplified, with separate digital processing and amplification for the LF and HF drivers. The processing incorporates sophisticated digital limiting specifically tailored to driver limitations on typical, real audio signals. The limiting is also specifically tailored to minimize reduction in sound quality when operating. This permits very high SPLs with little risk of damaging the drivers.

NT’s integral power amplifiers use proven, high efficiency, technology. The DSP settings for all models are stored in the amplifier assemblies, with dip switches to re-configure them for any model. While the likelihood of failure is small, a complete amplifier assembly for any NT full-range model or for the NTS22 subwoofer can be easily replaced in minutes.

NT enclosures have the same birch plywood construction as used in legendary EAW touring products. No weight-saving modifications impact the ruggedness of this construction. This same mechanical toughness extends to the amplifier design. This means NT loudspeakers are well-equipped to handle the physical rigors of hard, professional use.

**Summary:** EAW’s engineering efforts resulted in the NT Series: robust, compact, lightweight, loudspeakers that provide the pristine, transient performance, smooth frequency response, and lack of coloration of direct radiating, studio monitors. Unlike studio monitors, NT has the exceptional power, output, and directional capabilities as well as the mechanical durability required for professional PA applications.

Figures 1 to 4 (top to bottom)

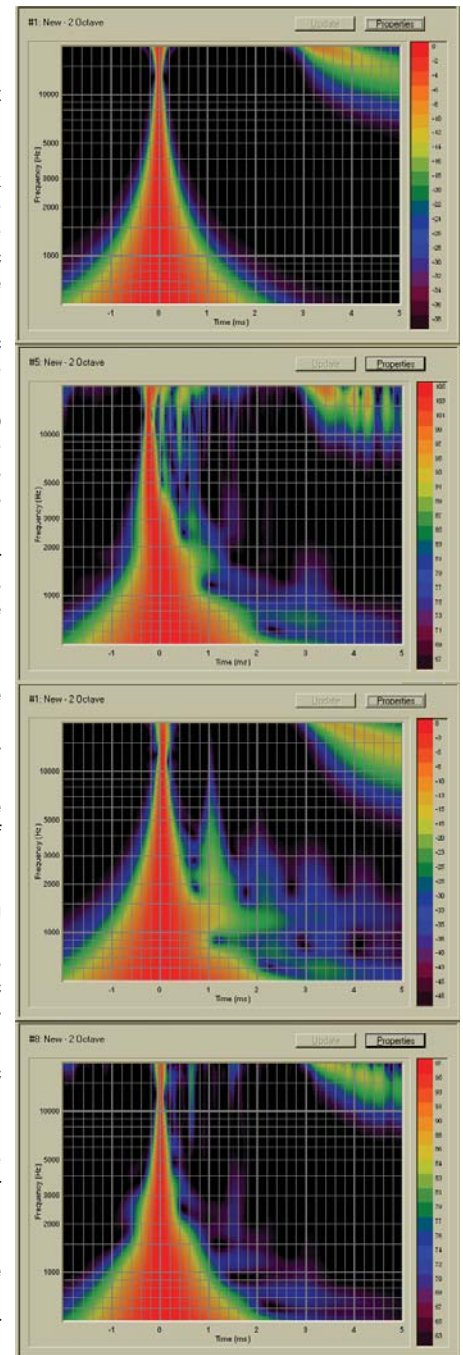

**SPECTROGRAMS:** EAW’s proprietary spectrograms show the spectrum or frequency content of sound (vertical axis) and its variation in time (horizontal axis), the colors representing intensity. The width of the data reflects the size of the sliding time window applied to the data, which increases in size with lower frequency. The “data” in the upper right is simply a limitation of the spectrograph’s mathematics and has no relevance.