



- NOTES:
1. SYMBOL  INDICATES MOUNTING POINT, 3/8-16 THREADED HOLE (PI ANGLE).
 2. SYMBOL  INDICATES CENTER OF BALANCE.
 3. WEIGHT APPROX. 154 LBS.
 4. SHIPPING WEIGHT APPROX. 172 LBS.
 5. ALLOW 4.00 CLEARANCE BEHIND CABINET FOR STRAIN RELIEF AND CABLE.

REV	DESCRIPTION	APVD/DATE
2	UPDATED TO CURRENT STANDARDS PER ECO #4651 DM 6/12/00.	KFH 6/13/00

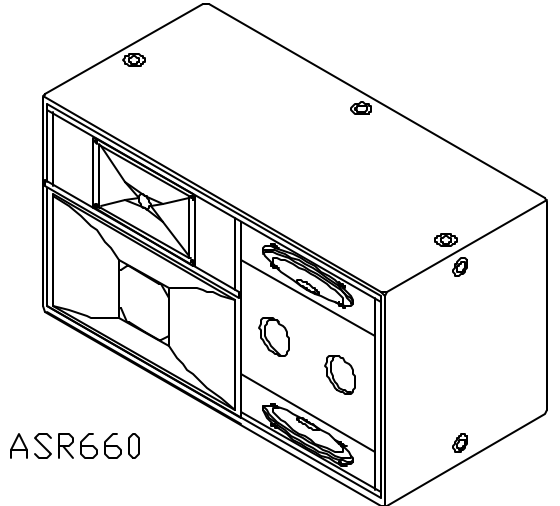
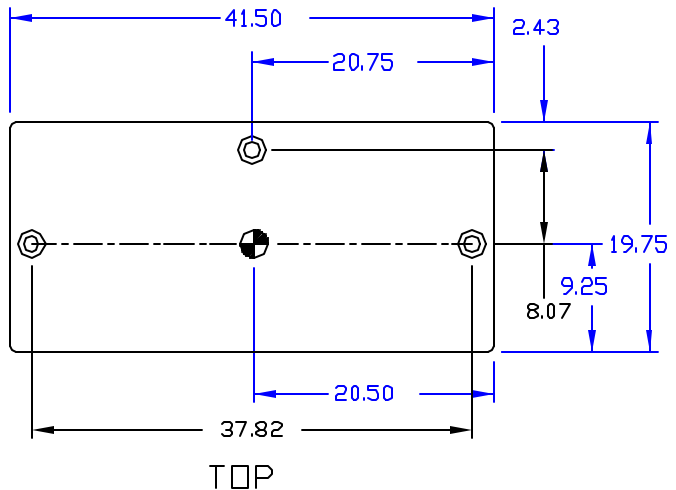

ASR660

TOP
DIMENSIONS APPLY TO
TOP & BOTTOM

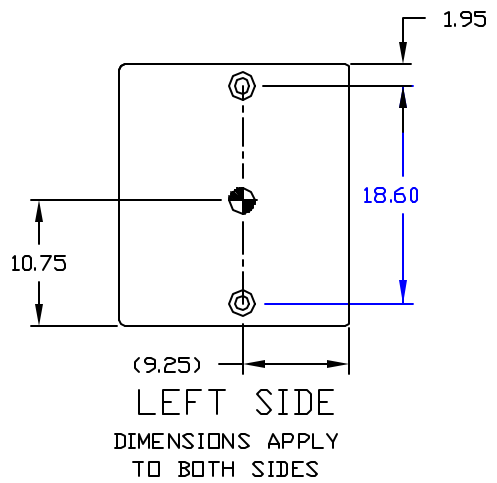

LEFT SIDE
DIMENSIONS APPLY
TO BOTH SIDES

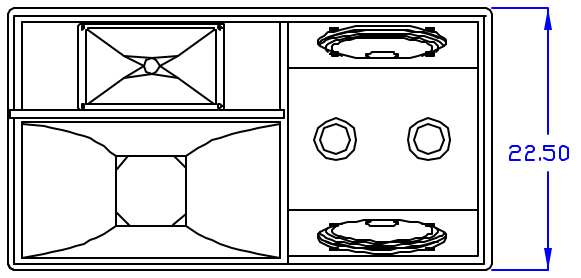

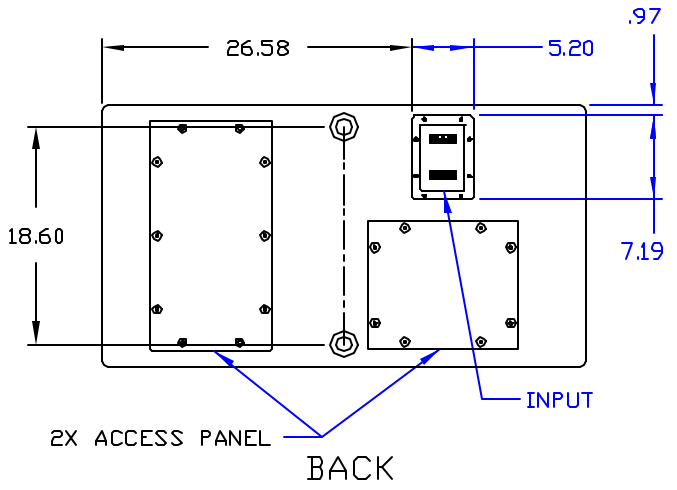

FRONT

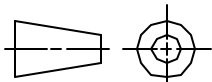

BACK
2X ACCESS PANEL
INPUT

DOCUMENT CONTROL PER SPECIFICATION 4.5.201

 THIRD ANGLE PROJECTION	UNLESS OTHERWISE SPECIFIED: ALL DIMENSIONS ARE IN INCHES TOLERANCE IN INCHES .XX ± .13 ANGLES ±1° (X.XX) = REF DIMS NO TOLERANCE IMPLIED T.S.C.=THEORETICAL SHARP CORNER DIMENSIONS ACROSS CENTERLINES TO BE SYMMETRICAL	STATUS: PRODUCTION		 EASTERN ACOUSTIC WORKS <small>ONE MAIN STREET WHITEHORSEVILLE, MA 01586 USA</small>	
		APPROVALS		DATE	
THIS DRAWING IS THE PROPERTY OF EAW AND SHALL NOT BE COPIED, REPRODUCED, OR USED AS THE BASIS FOR MANUFACTURE OR SALE OF APPARATUS WITHOUT WRITTEN AUTHORIZATION. DO NOT SCALE DRAWING		DRAWN: JAH		2/11/98	
		CHECKED: FEL		2/27/98	
		DES ENG: ZC		2/27/98	
		MFG ENG: KRV		2/27/98	
		DRAWING NUMBER: 510625		REVISION: 2	