



REV	DESCRIPTION	APVD/DATE
A	NEW ISSUE PER DSRWHT4915 DM 6/11/04	RS 6/16/04

NOTES:

1. SYMBOL  INDICATES MOUNTING POINT, 3/8-16 THREADED HOLE (PI ANGLE).
2. SYMBOL  INDICATES CENTER OF BALANCE.
3. WEIGHT APPROX. 113 LB.
4. SHIPPING WEIGHT APPROX. 133 LB.

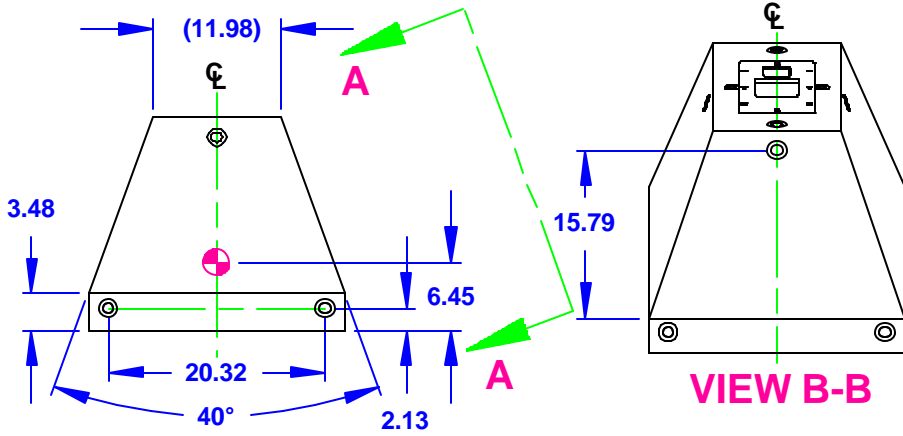
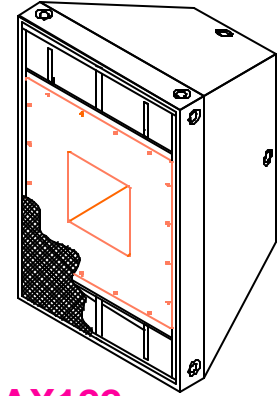

VIEW B-B

TOP DIMENSIONS APPLY TO TOP AND BOTTOM

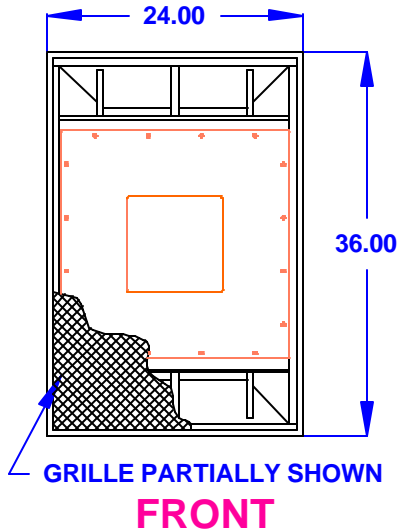

FRONT

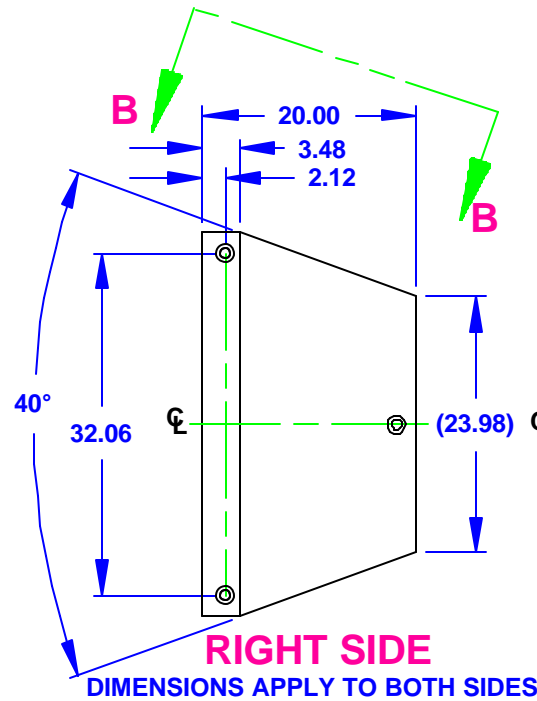

RIGHT SIDE DIMENSIONS APPLY TO BOTH SIDES

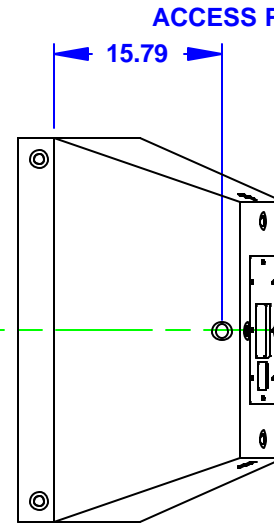

VIEW A-A

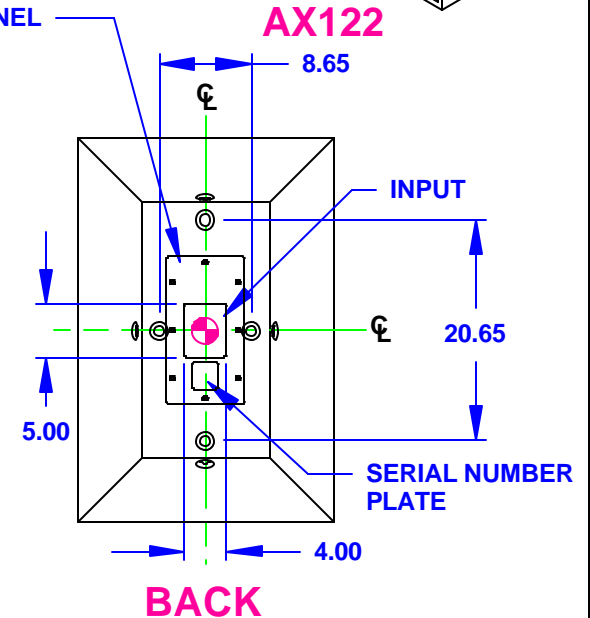

BACK

DOCUMENT CONTROL PER SPECIFICATION 4.5.201

THIRD ANGLE PROJECTION

THIS DRAWING IS THE PROPERTY OF EAW AND SHALL NOT BE COPIED, REPRODUCED, OR USED AS THE BASIS FOR MANUFACTURE OR SALE OF APPARATUS WITHOUT WRITTEN AUTHORIZATION. DO NOT SCALE DRAWING.

UNLESS OTHERWISE SPECIFIED: ALL DIMENSIONS ARE IN INCHES

TOLERANCE IN INCHES
 .XX ± .13
 ANGLES ± 1°

(X.XX) = REF DIMS
 NO TOLERANCE IMPLIED

T.S.C.=THEORETICAL SHARP CORNER

DIMENSIONS ACROSS CENTERLINES TO BE SYMMETRICAL

STATUS: PRODUCTION	
APPROVALS	DATE
DRAWN: DM	5/28/04
CHECKED: RS	6/17/04
DES ENG: NB	6/17/04
MFG ENG: SM	6/21/04

EAW EASTERN ACOUSTIC WORKS
 ONE MAIN STREET
 WHITINSVILLE, MA 01568 USA

TITLE: CABINET/FINISHED/BLACK/AX122
 [MECHANICAL SPECIFICATION]

A SHEET 1 OF 1 SCALE: 1 TO 18

DRAWING NUMBER: 0011328 REVISION: A