

JFX290i Specifications



FEATURES

- Ideal size and performance for rigorous all-purpose use
- 12-inch LF driver for best vocal and music reproduction
- 90° pattern optimized for use in stand-alone applications
- Asymmetric enclosure provides multiple mounting angles
- Pole mount & fly track plus Omnimount® Series 120.0 compatible mounting points
- User-selectable, single-amplified and bi-amplified operating modes

DESCRIPTION

The JFX290i full-range loudspeaker is a multi-functional design, adding considerably to its value as a full-range loudspeaker. It is an ideal size and output for wide range of programs. Combining high output capability with natural reproduction, it is specifically outfitted to serve in a variety of both portable and permanent applications.

The asymmetric enclosure provides typical angles needed for ceiling and wall mounting as well as for stage monitor operation. For portable use, provisions include a pole mount cup, top/bottom fly track for rigging, and handles integral to the enclosure that facilitate handling and transport. For permanent installation, enclosure hardware includes mounting points for an Omnimount® Series 120.0 or similar bracket and fly track for suspension.

The JFX290i is particularly suitable as a nearer field main loudspeaker, a fill/delay element in larger systems, for surround sound installations, and as voice and F/X reinforcement in themed attractions. Its wide angle projection makes audience coverage easy in a variety of situations. While the JFX290i is well suited as is for many applications, the addition of an SBX220 subwoofer, especially designed to complement the JFXi Series, expands the low frequency capabilities for more demanding applications. These include houses of worship, theaters, and band PA.

Six year warranty.

2-WAY FULL-RANGE 12-inch LF, 90°x 45°

See **NOTES TABULAR DATA** for details

CONFIGURATION

Subsystem

	Transducer	Loading
LF	1x 12 in cone	Vented
HF	1x 1.4 in exit, 3 in voice coil compression driver	CD horn

Operating Mode

	Amplifier Channels	External Signal Processing
Single-amp	LF/ HF	DSP
Bi-amp	LF, MF	DSP w/2-way filters

PERFORMANCE ¹

Operating Range	65 Hz to 20 kHz
------------------------	-----------------

Nominal Beamwidth

Horz	90°
Vert	45°

Axial Sensitivity (whole space SPL)

LF/HF	96 dB	65 Hz to 20 kHz
LF	96 dB	65 Hz to 1965 Hz
HF	105 dB	1240 Hz to 20 kHz

Input Impedance (ohms)

	Nominal	Minimum
LF/HF	8	6.1 @ 197 Hz
LF	8	6.1 @ 197 Hz
HF	8	9.0 @ 5540 Hz

High Pass Filter

High Pass	=>50 Hz, 12 dB/octave Butterworth
-----------	-----------------------------------

Accelerated Life Test ²

LF/HF	63 V	500 W @ 8 ohm
LF	63 V	500 W @ 8 ohm
HF	40 V	200 W @ 8 ohm

Calculated Axial Output Limit (whole space SPL)

	Average	Peak
LF/HF	122 dB	128 dB
LF	122 dB	128 dB
HF	128 dB	134 dB

ORDERING DATA

Description	Part Number
JFX290i 2-Way Full-Range Loudspeaker Black	0013497
Optional Accessories	
Fly Clip with Ring	0001386
Eyebolt/Forged Shoulder (3/8-16 x 1.25 in)	104001

¹ To achieve specified performance, the listed external signal processing with EAW-provided settings is required.

² For recommendations to select power amplifier size refer to: "HOW MUCH AMPLIFIER POWER DO I NEED?" on the EAW web site.

JFX290i Specifications

ENCLOSURE

Material	Baltic birch plywood
Finish	Wear resistant textured black paint
Grille	Powder-coated perforated steel

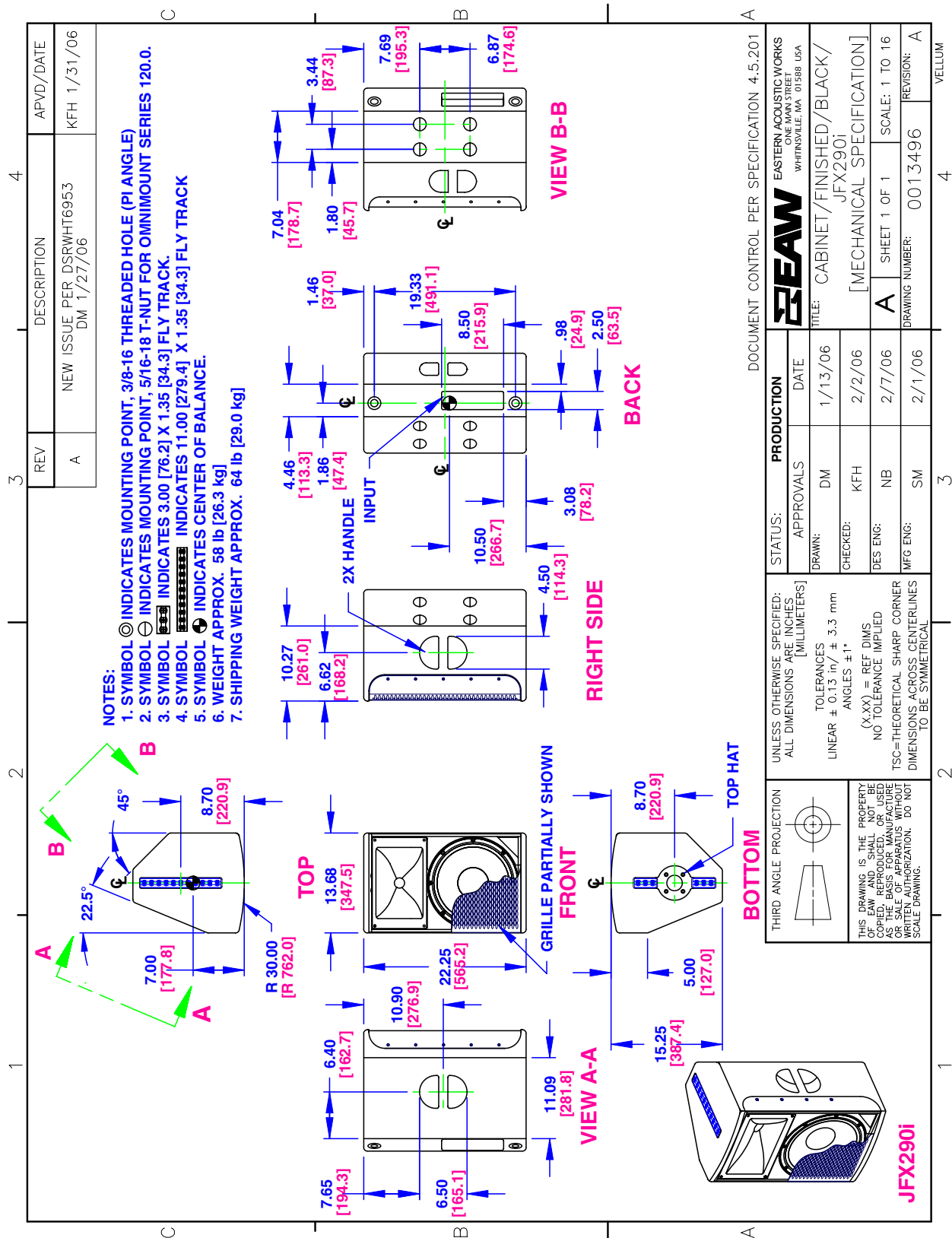

NOTE: This drawing has been reduced. Do not scale.



JFX290i Specifications

PERFORMANCE DATA

See **NOTES GRAPHIC DATA** for details

Frequency Response: Processed Bi-amplified

LF = green, HF = black, Complete = blue

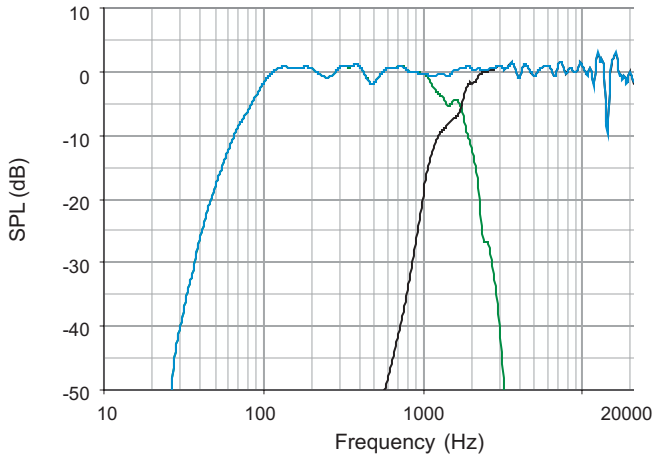

Frequency Response: Processed Single-amplified

Complete = blue

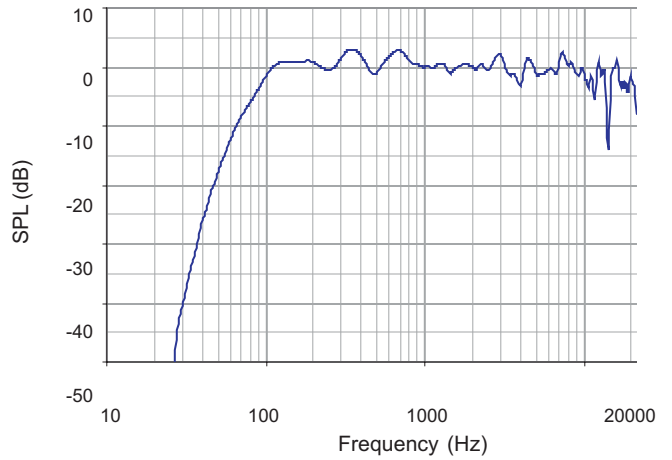

Frequency Response: Unprocessed

LF = green, HF = black, Single-amp = blue

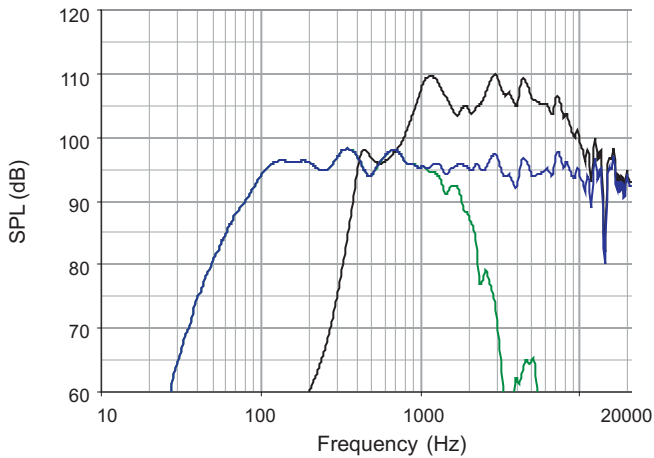

Frequency Response: Digital Signal Processor

LF = green, HF = black, Single-amp = blue

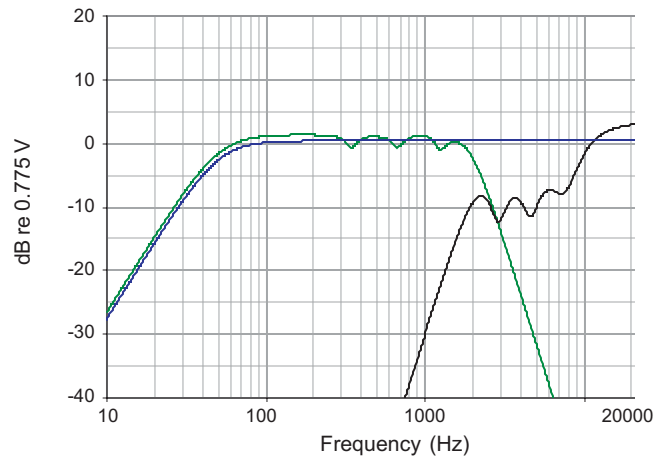

Impedance Magnitude

LF = green, HF = black, Single-amp = blue

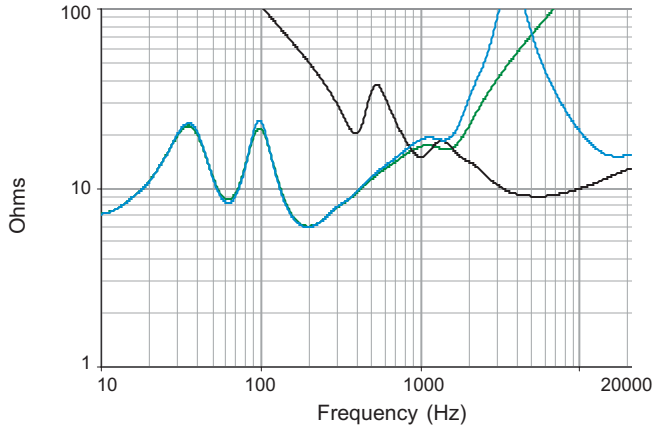

Beamwidth (-6 dB SPL Points)

Horizontal = orange Vertical = black

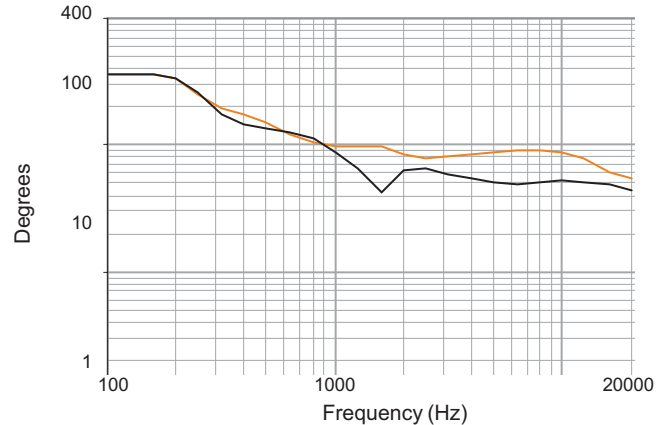

JFX290i Specifications

HORIZONTAL POLAR DATA (Gridlines: 6 dB axial / 15 degree radial)

See **NOTES GRAPHIC DATA** for details

100 Hz
125 Hz
160 Hz
200 Hz

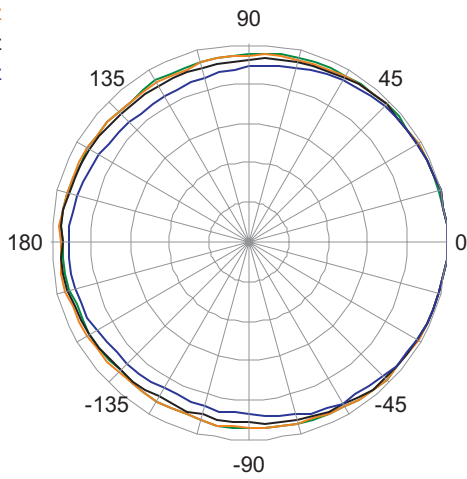

1600 Hz
2000 Hz
2500 Hz
3150 Hz

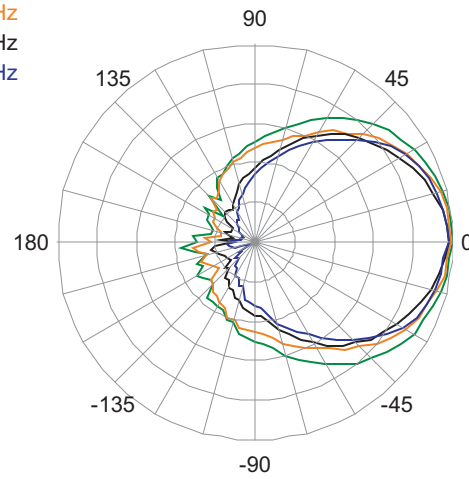

250 Hz
315 Hz
400 Hz
500 Hz

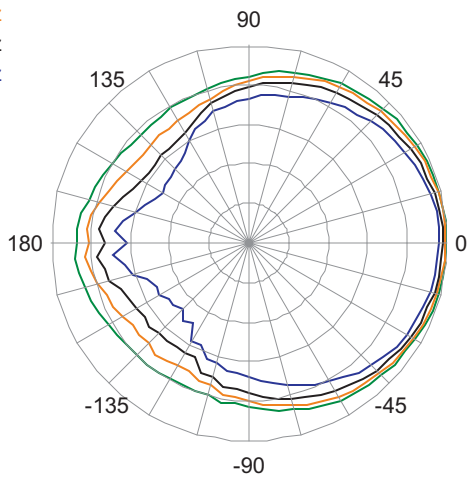

4000 Hz
5000 Hz
6300 Hz
8000 Hz

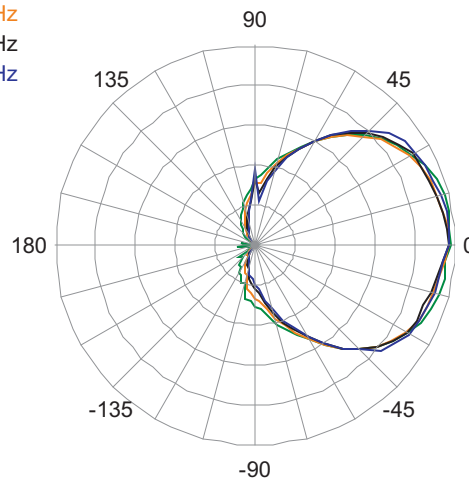

630 Hz
800 Hz
1000 Hz
1250 Hz

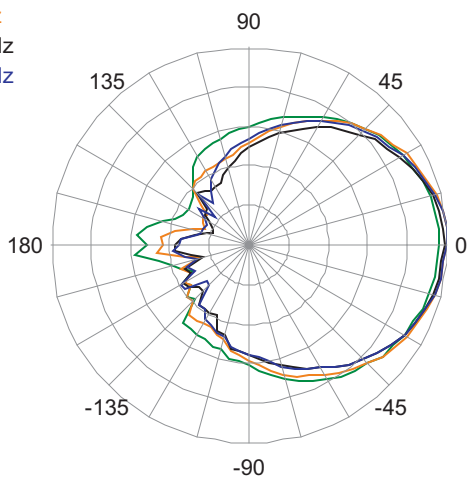

10000 Hz
12000 Hz
16000 Hz

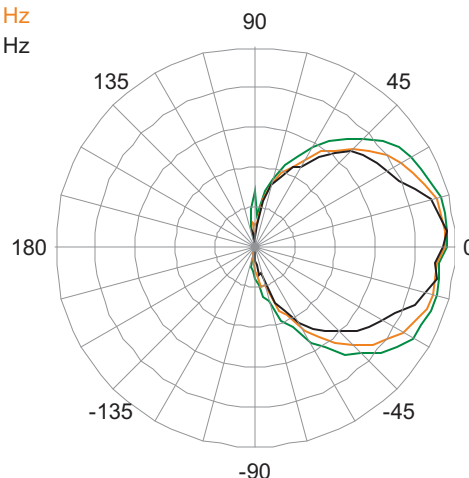

JFX290i Specifications

VERTICAL POLAR DATA (Gridlines: 6 dB axial / 15 degree radial)

See **NOTES GRAPHIC DATA** for details

100 Hz
125 Hz
160 Hz
200 Hz

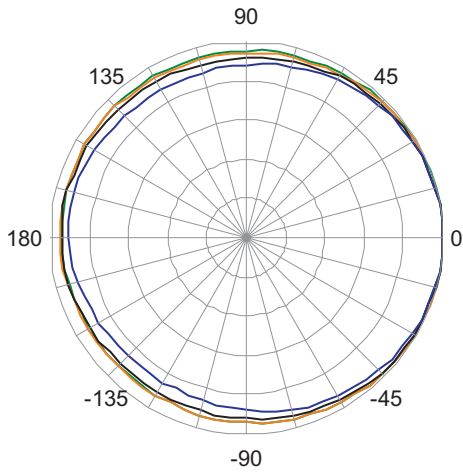

1600 Hz
2000 Hz
2500 Hz
3150 Hz

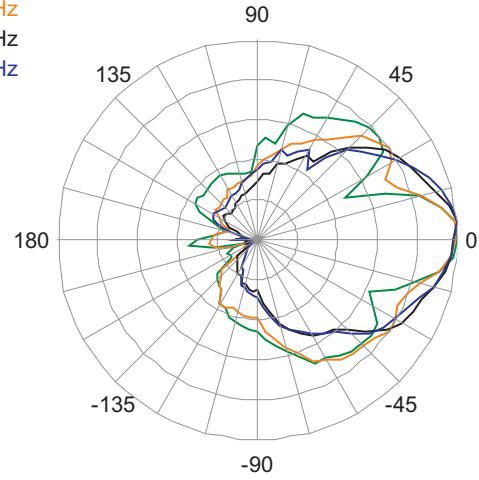

250 Hz
315 Hz
400 Hz
500 Hz

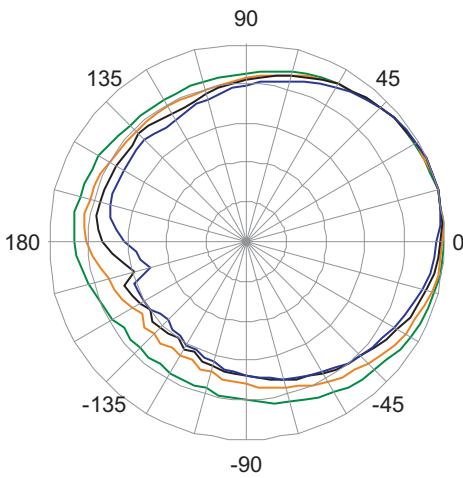

4000 Hz
5000 Hz
6300 Hz
8000 Hz

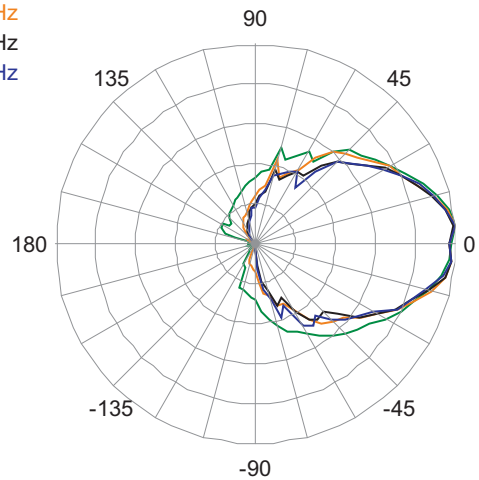

630 Hz
800 Hz
1000 Hz
1250 Hz

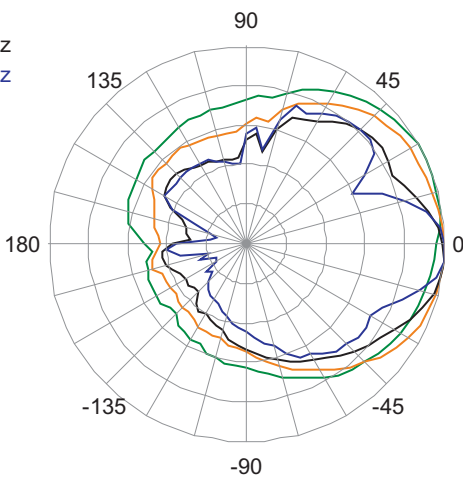

10000 Hz
12000 Hz
16000 Hz

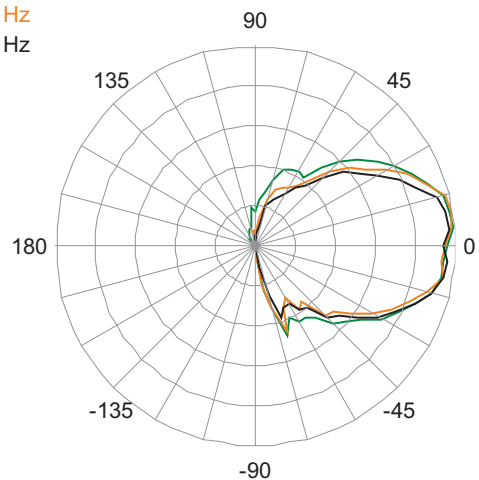

JFX290i Specifications

INPUT PANEL

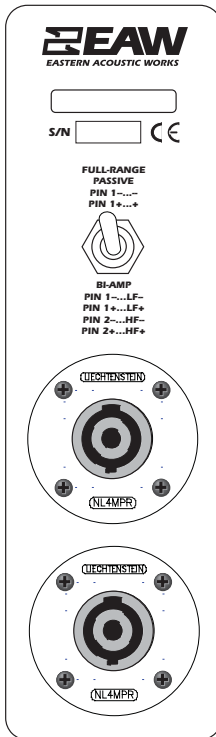

SIGNAL DIAGRAM

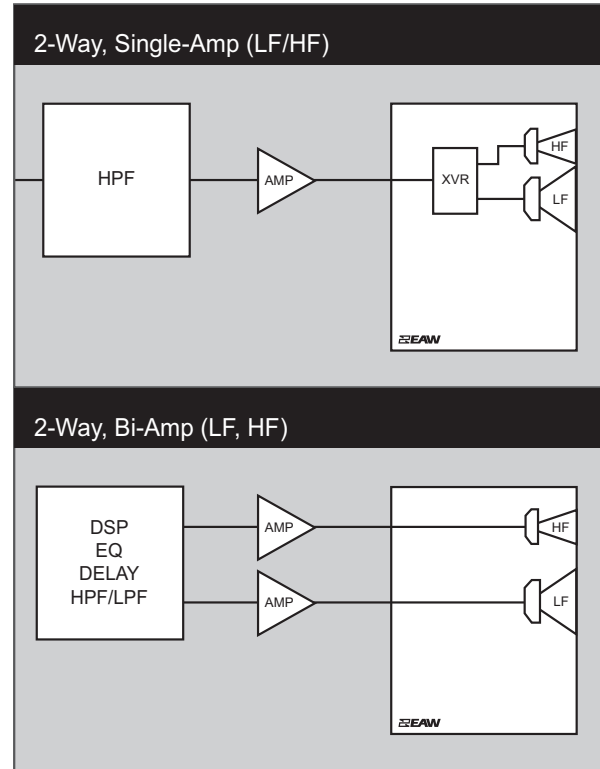

LEGEND

DSP:	User-supplied Digital Signal Processor.
HPF:	High Pass Filter for crossover or Recommended High Pass Filter.
LPF:	Low Pass Filter for crossover.
LF/MF/HF:	Low Frequency / Mid Frequency / High Frequency.
AMP:	User-supplied Power Amplifier.
XVR:	Passive LPFs, HPFs, and EQ integral to the loudspeaker.

NOTES

TABULAR DATA

- Measurement/Data Processing Systems:** Primary - FChart: proprietary EAW software; Secondary - Brüel & Kjær 2012.
- Microphone Systems:** Earthworks M30; Brüel & Kjær 4133
- Measurements:** Dual channel FFT; length: 32 768 samples; sample rate: 48 kHz; logarithmic sine wave sweep.
- Measurement System Qualification** (includes all uncertainties): SPL: accuracy +/-0.2 dB @ 1 kHz, precision +/-0.5 dB 20 Hz to 20 kHz, resolution 0.05 dB; Frequency: accuracy +/-1 %, precision +/-0.1 Hz, resolution the larger of 1.5 Hz or 1/48 octave; Time: accuracy +/-10.4 µs, precision +/-0.5 µs, resolution 10.4 µs; Angular: accuracy +/-1°, precision +/-0.5°, resolution 0.5°.
- Environment:** Measurements time-windowed and processed to eliminate room effects, approximating an anechoic environment. Data processed as anechoic or fractional space, as noted.
- Measurement Distance:** 7.46 m. Acoustic responses represent complex summation of the subsystems at 20 m. SPL is referenced to other distances using the Inverse Square Law.
- Enclosure Orientation:** For beamwidth and polar specifications, as shown in Mechanical Specification drawing.
- Volts:** Measured rms value of the test signal.
- Watts:** Per audio industry practice, "loudspeaker watts" are calculated as voltage squared divided by rated nominal impedance. Thus, these are not True Watt units of energy as defined by International Standard.
- SPL:** (Sound Pressure Level) Equivalent to the average level of a signal referenced to 0 dB SPL = 20 microPascals.
- Subsystem:** This lists the transducer(s) and their acoustic loading for each passband. Sub = Subwoofer, LF = Low Frequency, MF = Mid Frequency, HF = High Frequency.
- Operating Mode:** User selectable configurations. Between system elements, a comma (,) = separate amplifier channels; a slash (/) = single amplifier channel. DSP = Digital Signal Processor. IMPORTANT: To achieve the specified performance, the listed external signal processing must be used with EAW-provided settings.
- Operating Range:** Range where the processed Frequency Response stays within -10 dB SPL of the power averaged SPL within this range; measured on the geometric axis. Narrow band dips are accepted.
- Nominal Beamwidth:** Design angle for the -6 dB SPL points, referenced to 0 dB SPL as the highest level.
- Axial Sensitivity:** Power averaged SPL over the Operating Range with an input voltage that would produce 1 W at the nominal impedance; measured with no external processing on the geometric axis, referenced to 1 m.
- Nominal Impedance:** Selected 4, 8, or 16 ohm resistance such that the minimum impedance point is no more than 20% below this resistance over the Operating Range.
- Accelerated Life Test:** Maximum test input voltage applied with an EIA-426B defined spectrum; measured with recommended signal processing and Recommended Protection Filter.
- Calculated Axial Output Limit:** Highest average and peak SPLs possible during the Accelerated Life Test. The Peak SPL represents the 2:1 (6 dB) crest factor of the Life Test signal.
- High Pass Filter:** This helps protect the loudspeaker from excessive input signal levels at frequencies below the Operating Range.

GRAPHIC DATA

- Resolution:** To remove insignificant fine details, 1/12 octave cepstral smoothing was applied to acoustic frequency responses and 1/3 octave cepstral smoothing was applied to the beamwidth and impedance data. Other graphs are plotted using raw data.
- Frequency Responses:** Variation in acoustic output level with frequency for a constant input signal. Processed: normalized to 0 dB SPL. Unprocessed inputs: 2 V (4 ohm nominal impedance), 2.83 V (8 ohm nominal impedance), or 4 V (16 ohm nominal impedance) referenced to a distance of 1 m.
- Processor Response:** The variation in output level with frequency for a constant input signal of 0.775 V = 0 dB reference.
- Beamwidth:** Average angle for each 1/3 octave frequency band where, starting from the rear of the loudspeaker, the output first reaches -6 dB SPL referenced to 0 dB SPL as the highest level. This method means the output may drop below -6 dB SPL within the beamwidth angle.
- Impedance:** Variation in impedance magnitude, in ohms, with frequency without regard to voltage/current phase. This means the impedance values may not be used to calculate True Watts (see 9 above).
- Polar Data:** Horizontal and vertical polar responses for each 1/3 octave frequency band 100 Hz to 16 kHz or Operating Range.