



FEATURES

- QX Companion Sub
- Installation Flexibility

APPLICATIONS

Houses of worship, arenas, outdoor stadiums, performing arts venues, theaters and clubs

DESCRIPTION

The QX118 is the companion subwoofer for QX Series loudspeakers. Designed to extend the low frequency response of QX arrays to 30 Hz, this compact subwoofer features a high power 18" producing an exceptional amount of output. While the operating range is specified to 150 Hz when used with full-range QX products, the QX118 is capable of extended response to serve as an LF subsystem for MF/HF loudspeakers.

The barrier strip input connector for the QX118 has a second set of "loop thru" terminals for connecting an additional QX118.

Six year warranty.

18 INCH SUBWOOFER

See *NOTES TABULAR DATA* for details, half space = floor-mounted

CONFIGURATION

Subsystem:		
	Transducer	Loading
	SUB 1x 18 in cone	Vented

Operating Mode:		
	Amplifier Channels	External Signal Processing
	Single-amp LF	DSP w/1-way filter

PERFORMANCE

Operating Range: 30 Hz to 150 Hz

Nominal Beamwidth:		
	Horz 360°	
	Vert 360°	

Axial Sensitivity (SPL):		
	LF (whole space) 94 dB	30 Hz to 150 Hz
	(half space) 100 dB	30 Hz to 150 Hz

Input Impedance (ohms)		
	Nominal	Minimum
	LF 8	7.1 @ 150 Hz

High Pass Filter		
	High Pass =>30 Hz, 24 dB/octave Butterworth	

Accelerated Life Test		
System	LF 80 V	800 W @ 8 ohm

Calculated Axial Output Limit (SPL)		
	Average	Peak
	LF (whole space) 123 dB	129 dB
	(half space) 129 dB	135 dB

ORDERING DATA

Description	Part Number
EAW QX118 18 inch Subwoofer Black	2035610
Optional Accessories	
Adapter Bracket QX BLK [ACC-ABQX]	2036437
Weather Protection Shield QX BLK [ACC-WPSQX]	2036515
U-Bracket Horizontal QX BLK [UBKT-QXH]	2036568

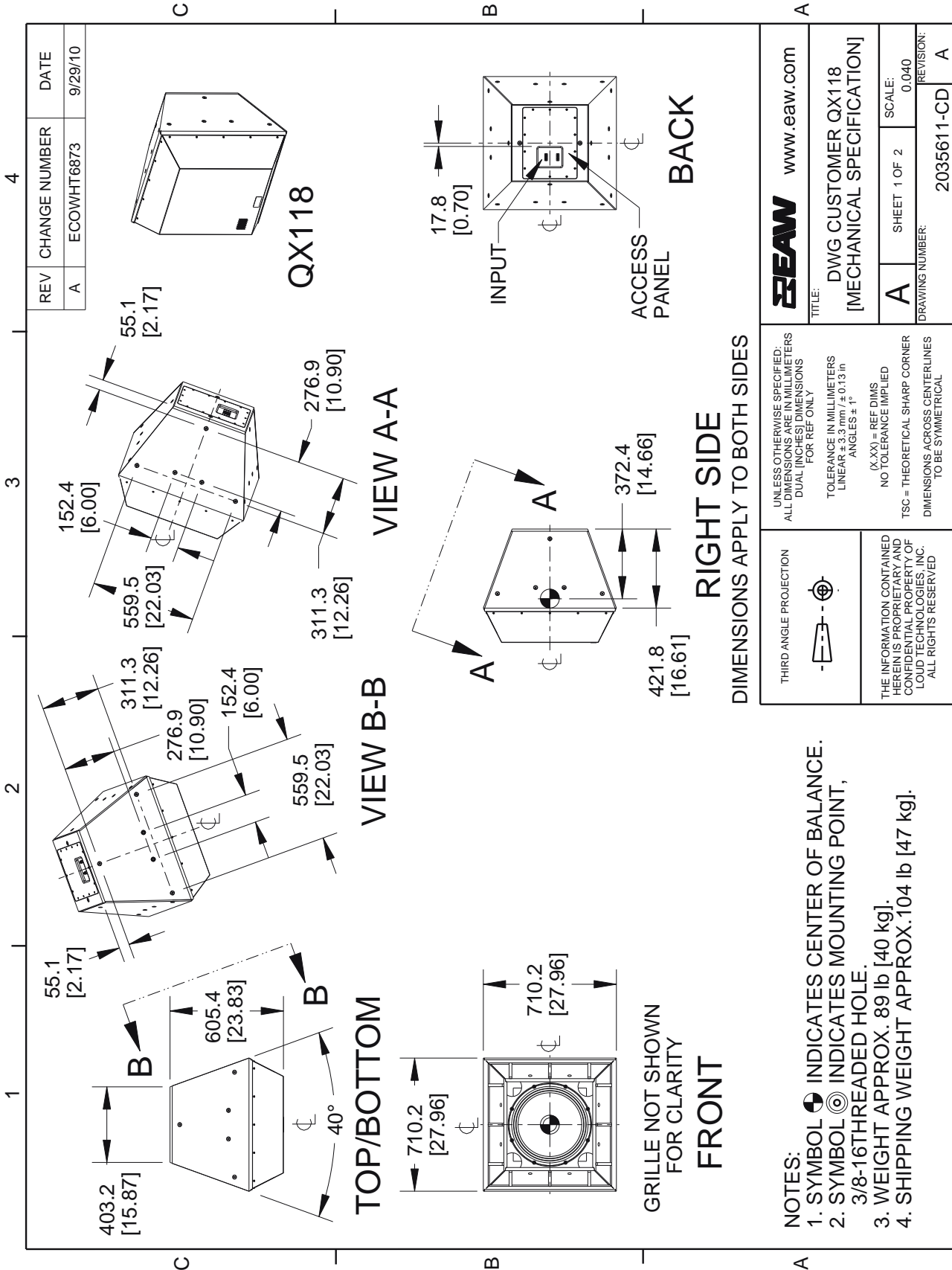

NOTE: This drawing has been reduced. Do not scale.

PERFORMANCE DATA

See *NOTES GRAPHIC DATA* for details

Frequency Response: Processed

LF = green

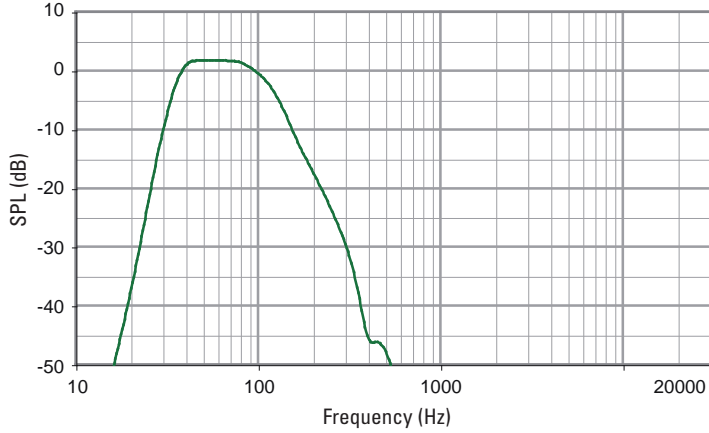

Frequency Response: Unprocessed

LF = green

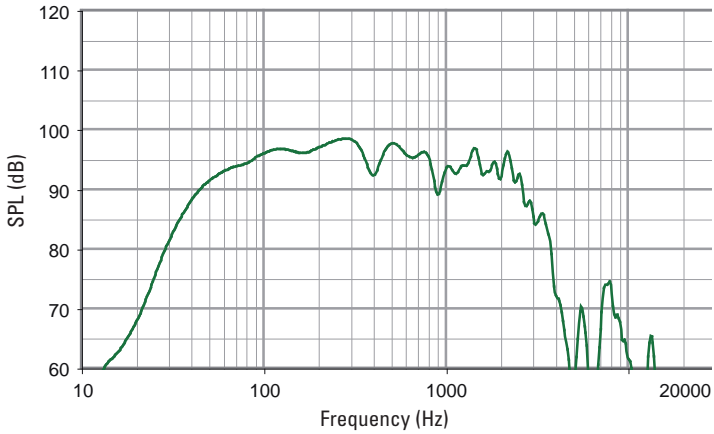

Processor Response

LF = green

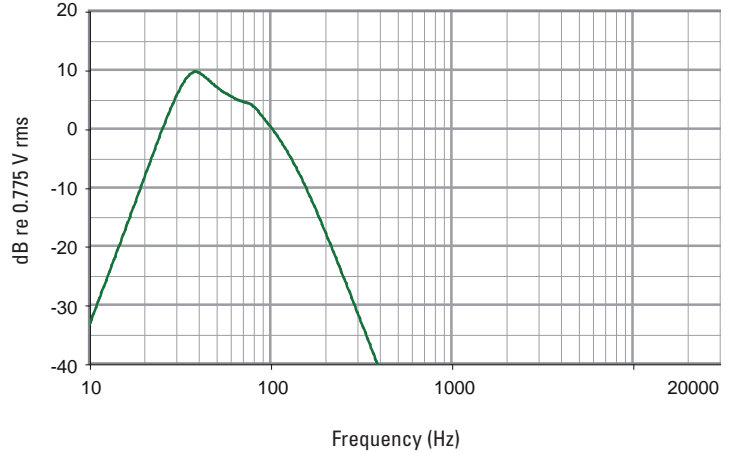

Impedance

LF = green

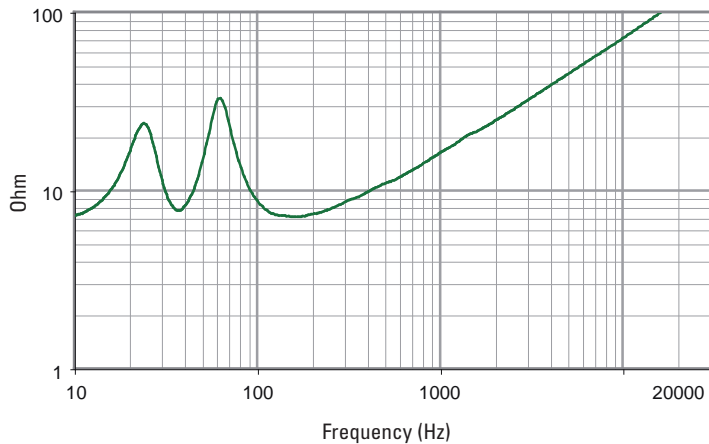

INPUT PANEL

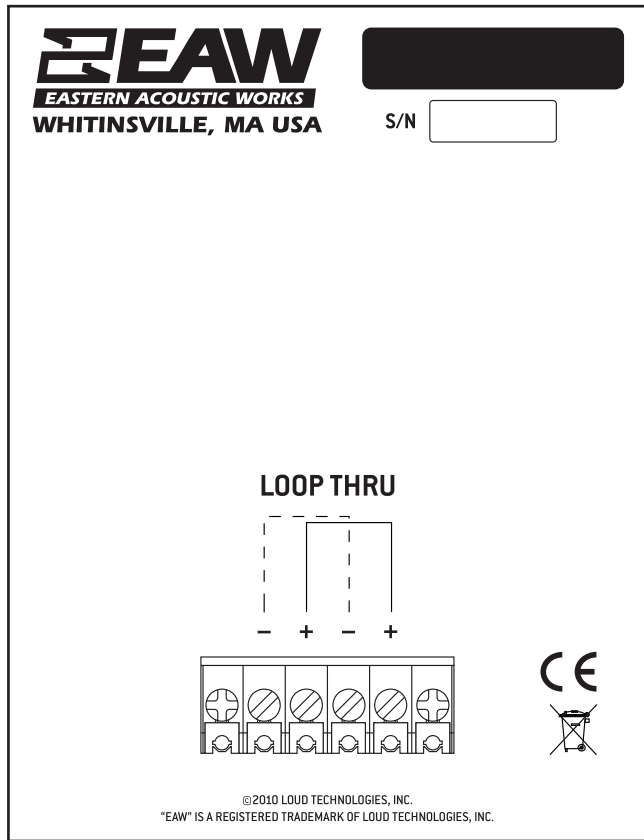

SIGNAL DIAGRAM

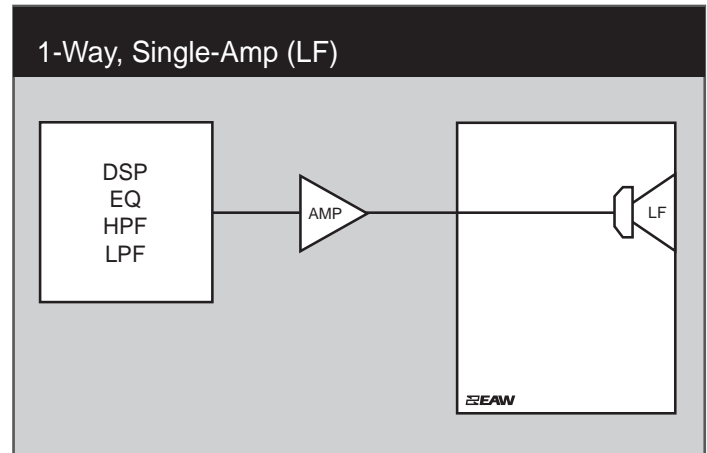

LEGEND

- DSP:** EAW UX8800 Digital Signal Processor –or– Integral Digital Signal Processing for NT products.
- HPF:** High Pass Filter for crossover –or– Recommended High Pass Filter.
- LPF:** Low Pass Filter for crossover.
- LF/MF/HF:** Low Frequency / Mid Frequency / High Frequency.
- AMP:** User Supplied Power Amplifier –or– Integral Amplifier for NT products.
- XVR:** Passive LPFs, HPFs, and EQ integral to the loudspeaker.

NOTES

TABULAR DATA

1. **Measurement/Data Processing Systems:** Primary - FChart: proprietary EAW software; Secondary - Brüel & Kjær 2012.
2. **Microphone Systems:** Earthworks M30; Brüel & Kjær 4133
3. **Measurements:** Dual channel FFT; length: 32 768 samples; sample rate: 48 kHz; logarithmic sine wave sweep.
4. **Measurement System Qualification** (includes all uncertainties): SPL: accuracy +/-0.2 dB @ 1 kHz, precision +/-0.5 dB 20 Hz to 20 kHz, resolution 0.05 dB; Frequency: accuracy +/-1 %, precision +/-0.1 Hz, resolution the larger of 1.5 Hz or 1/48 octave; Time: accuracy +/-10.4 µs, precision +/-0.5 µs, resolution 10.4 µs; Angular: accuracy +/-1°, precision +/-0.5°, resolution 0.5°.
5. **Environment:** Measurements time-windowed and processed to eliminate room effects, approximating an anechoic environment. Data processed as anechoic or fractional space, as noted.
6. **Measurement Distance:** 7.46 m. Acoustic responses represent complex summation of the subsystems at 20 m. SPL is referenced to other distances using the Inverse Square Law.
7. **Enclosure Orientation:** For beamwidth and polar specifications, as shown in Mechanical Specification drawing.
8. **Volts:** Measured rms value of the test signal.
9. **Watts:** Per audio industry practice, "loudspeaker watts" are calculated as voltage squared divided by rated nominal impedance. Thus, these are not True Watt units of energy as defined by International Standard.
10. **SPL:** (Sound Pressure Level) Equivalent to the average level of a signal referenced to 0 dB SPL = 20 microPascals.
11. **Subsystem:** This lists the transducer(s) and their acoustic loading for each passband. Sub = Subwoofer, LF = Low Frequency, MF = Mid Frequency, HF = High Frequency.
12. **Operating Mode:** User selectable configurations. Between system elements, a comma (,) = separate amplifier channels; a slash (/) = single amplifier channel. DSP = Digital Signal Processor. **IMPORTANT:** To achieve the specified performance, the listed external signal processing must be used with EAW-provided settings.
13. **Operating Range:** Range where the processed Frequency Response stays within -10 dB SPL of the power averaged SPL within this range; measured on the geometric axis. Narrow band dips are excepted.
14. **Nominal Beamwidth:** Design angle for the -6 dB SPL points, referenced to 0 dB SPL as the highest level.
15. **Axial Sensitivity:** Power averaged SPL over the Operating Range with an input voltage that would produce 1 W at the nominal impedance; measured with no external processing on the geometric axis, referenced to 1 m.
16. **Nominal Impedance:** Selected 4, 8, or 16 ohm resistance such that the minimum impedance point is no more than 20% below this resistance over the Operating Range.
17. **Accelerated Life Test:** Maximum test input voltage applied with an EIA-426B defined spectrum; measured with recommended signal processing and Recommended Protection Filter.
18. **Calculated Axial Output Limit:** Highest average and peak SPLs possible during the Accelerated Life Test. The Peak SPL represents the 2:1 (6 dB) crest factor of the Life Test signal.
19. **High Pass Filter:** This helps protect the loudspeaker from excessive input signal levels at frequencies below the Operating Range.

GRAPHIC DATA

1. **Resolution:** To remove insignificant fine details, 1/12 octave cepstral smoothing was applied to acoustic frequency responses and 1/3 octave cepstral smoothing was applied to the beamwidth and impedance data. Other graphs are plotted using raw data.
2. **Frequency Responses:** Variation in acoustic output level with frequency for a constant input signal. Processed: normalized to 0 dB SPL. Unprocessed inputs: 2 V (4 ohm nominal impedance), 2.83 V (8 ohm nominal impedance), or 4 V (16 ohm nominal impedance) referenced to a distance of 1 m.
3. **Processor Response:** The variation in output level with frequency for a constant input signal of 0.775 V = 0 dB reference.
4. **Beamwidth:** Average angle for each 1/3 octave frequency band where, starting from the rear of the loudspeaker, the output first reaches -6 dB SPL referenced to 0 dB SPL as the highest level. This method means the output may drop below -6 dB SPL within the beamwidth angle.
5. **Impedance:** Variation in impedance magnitude, in ohms, with frequency without regard to voltage/current phase. This means the impedance values may not be used to calculate True Watts (see 9 above).
6. **Polar Data:** Horizontal and vertical polar responses for each 1/3 octave frequency band 100 Hz to 16 kHz or Operating Range.