

MK2364i Specifications

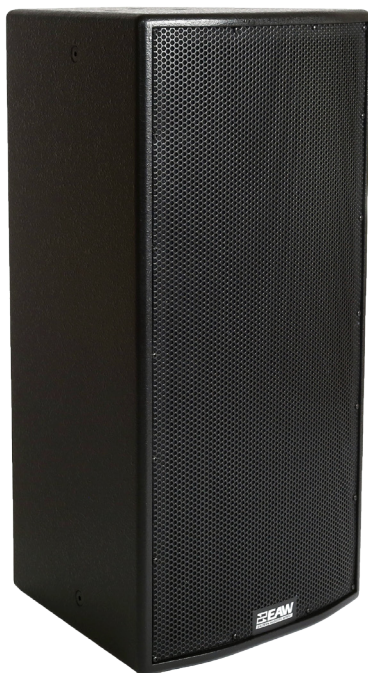

DESCRIPTION

- Premium Performance
- Application Flexibility

The MK2300i Series of 2-way, high output, trapezoidal loudspeaker systems are designed as main PA elements for smaller venues, including small houses of worship and auditoriums/theaters, corporate A/V systems, hotel ballrooms and meeting rooms. The Series is also excellent for distributed or fill purposes in larger venues, including large houses of worship and auditoriums/theaters, arenas, stadiums, nightclubs, and themed-entertainment complexes.

To meet the design goals for the intended applications, EAW engineers developed a new, high performance, 3-inch voice coil, 1.4-in exit compression driver, loading it with a selection of six different HF horns with coverage patterns ranging from 60° x 45° to 120° x 60°. The horns are as large as the enclosure size allows to maintain consistent directivity throughout the HF passband. A 3-inch voice coil, 12-inch LF driver was used to complement the sonic character and output of the HF driver. All MK2300i models are carefully voiced to sound similar, permitting diverse horn patterns to be mixed throughout an installation while maintaining the same sonic quality. The result is clean, high-fidelity output at significantly higher levels than would be expected from loudspeakers of this size and price.

Users can select between single-amp and bi-amp (external processor) operating modes. In either operating mode, EAW's beamwidth-matching crossover/filter design delivers even power response throughout the crossover region, eliminating the discontinuities that plague other two-way loudspeakers.

The MK2300i Series systems are the smaller companions to the MK5300i Series systems. Enclosures for both series are the same height, facilitating installation where more than one horn pattern and/or type of loudspeaker capability is needed. In addition, SBK Series subwoofers also share this height, creating attractive arrays that use EAW's preconfigured accessory flybar.

Six Year Warranty.

2-WAY FULL-RANGE LOUDSPEAKER 60° x 45°

See *NOTES TABULAR DATA* for details

CONFIGURATION

Subsystem:

	Transducer	Loading
LF	1 x 12 in cone	Vented
HF	1 x 1.4 in exit, 3 in voice coil compression driver	Horn-loaded

Operating Mode:

	Amplifier Channels	External Signal Processing
Single-amp	LF/HF	High pass filter
Bi-amp	LF,HF	DSP w/2-way filters

PERFORMANCE

Operating Range: 65 Hz to 16 kHz

Nominal Beamwidth: (rotatable)

Horz 60°

Vert 45°

Axial Sensitivity (whole space SPL):

LF/HF	95 dB	65 Hz to 16 kHz
LF	97 dB	65 Hz to 1400 Hz
HF	107 dB	1200 Hz to 16 kHz

Input Impedance (ohms):

	Nominal	Minimum
LF/HF	8	7.6 @ 180 Hz
LF	8	6.9 @ 290 Hz
HF	8	6.8 @ 3100 Hz

High Pass Filter: High Pass =>60 Hz, 12 dB/octave Butterworth

Accelerated Life Test:

LF/HF	69.3 V	600 W @ 8 ohm
LF	69.3 V	600 W @ 8 ohm
HF	34.6 V	150 W @ 8 ohm

Calculated Axial Output Limit (whole space SPL):

	Average	Peak
LF/HF	123 dB	129 dB
LF	125 dB	131 dB
HF	129 dB	135 dB

ORDERING DATA

Description	Part Number
EAW MK2364i 2-Way Full-Range Loudspeaker Black	2039722
EAW MK2364i 2-Way Full-Range Loudspeaker White	2039728
EAW MK2364i 2-Way Full-Range Loudspeaker Black-WP	2039734

Optional Accessories

EAW ACC Eye Bolt 0.375-16 X 1.25 in [ACC-EB3825]	104001
EAW U-Bracket MK2(5)000 Black [UBKT2353]	0007869
EAW U-Bracket MK2(5)000 White [UBKT2353]	0015076
EAW Flybar SBK-MK23 VFS-VFR129 Black [FB2VSK]	2038319



MK2364i Specifications

ENCLOSURE

- Material Exterior-grade Baltic birch plywood
- Finish Wear resistant textured black paint
- Grille Powder-coated perforated steel

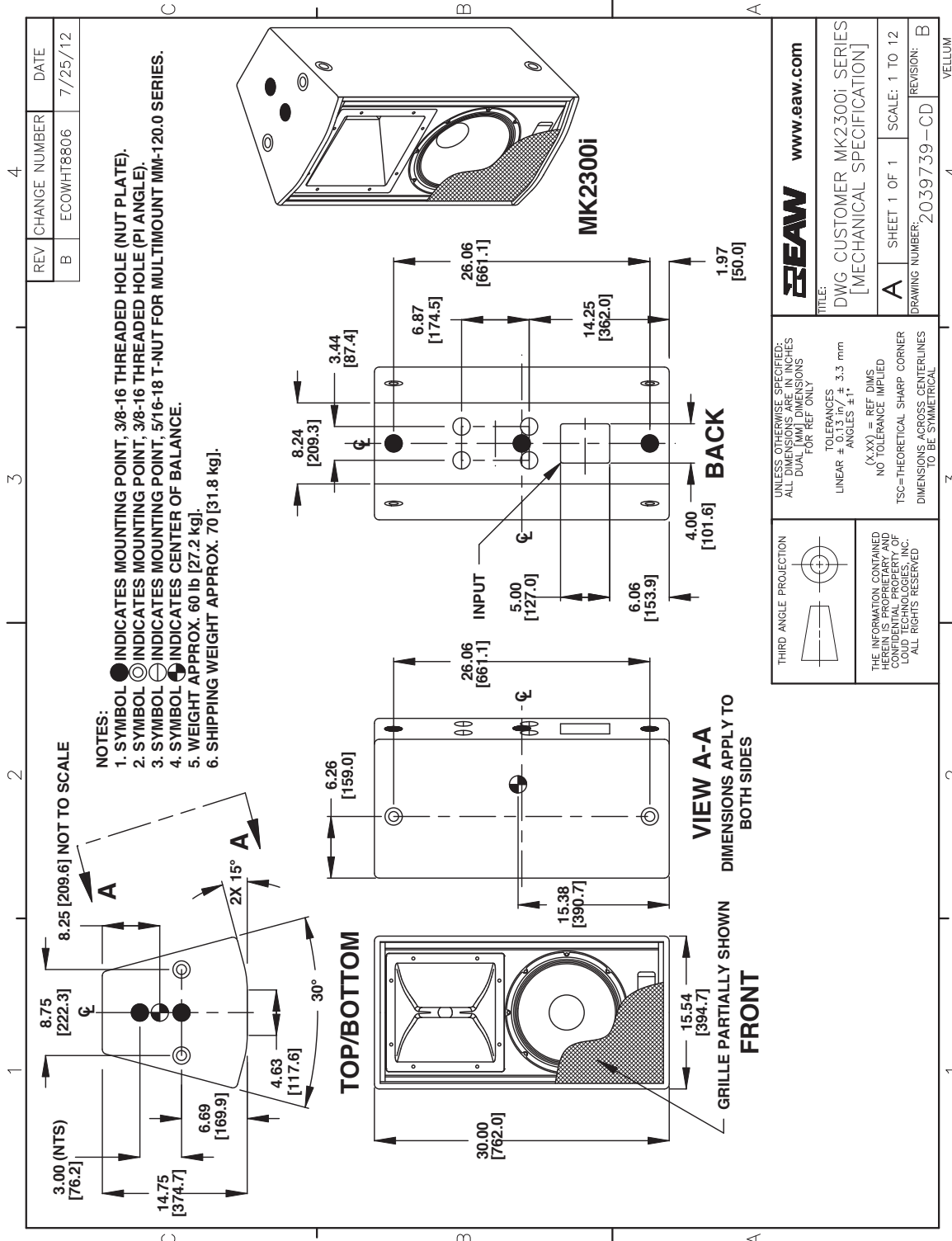

NOTE: This drawing has been reduced. Do not scale.

MK2364i Specifications

PERFORMANCE DATA

See *NOTES GRAPHIC DATA* for details

Frequency Response: Processed

LF = green, HF = black, Complete = blue

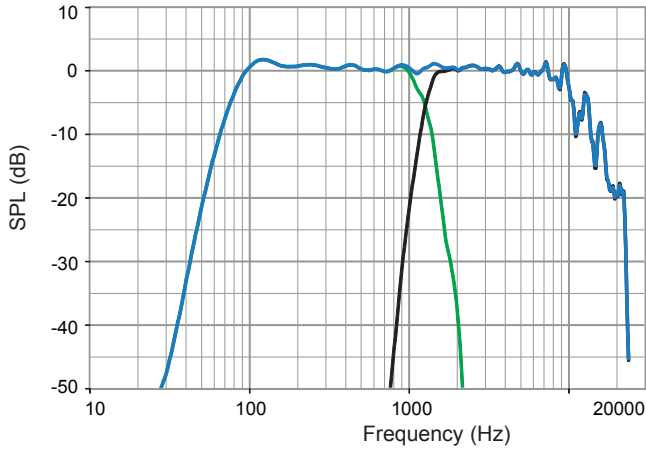

Frequency Response: Unprocessed

LF = green, HF = black, Complete = blue

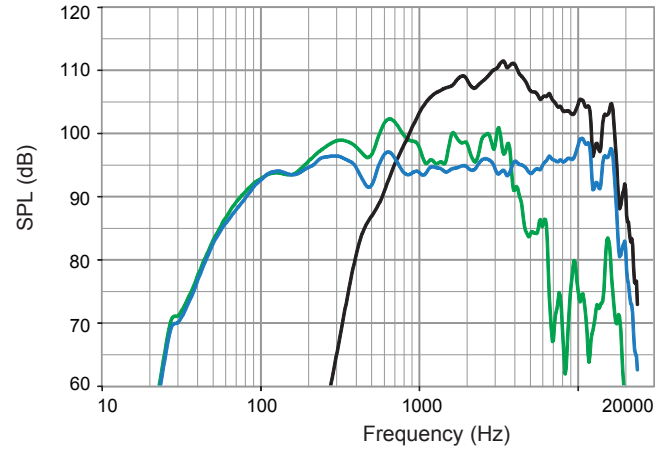

Impedance

LF = green, HF = black, Complete = blue

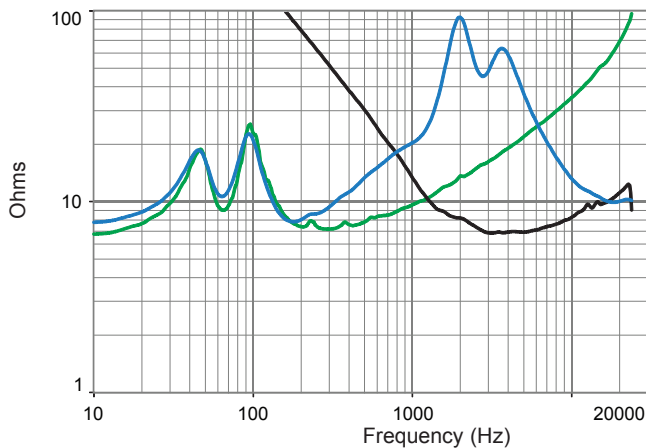

Phase Linearity

Complete = blue

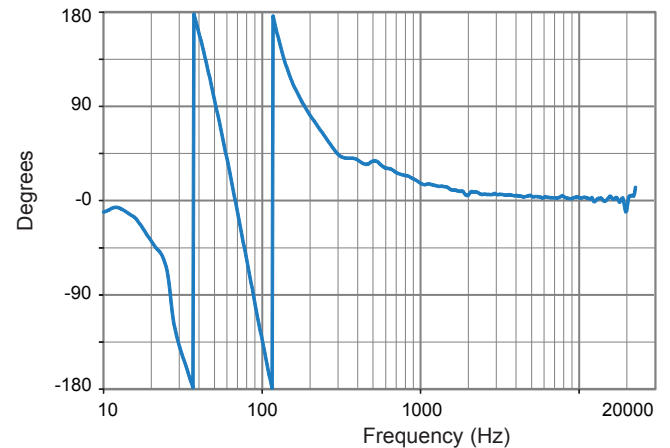

Beamwidth

Horizontal = orange Vertical = black

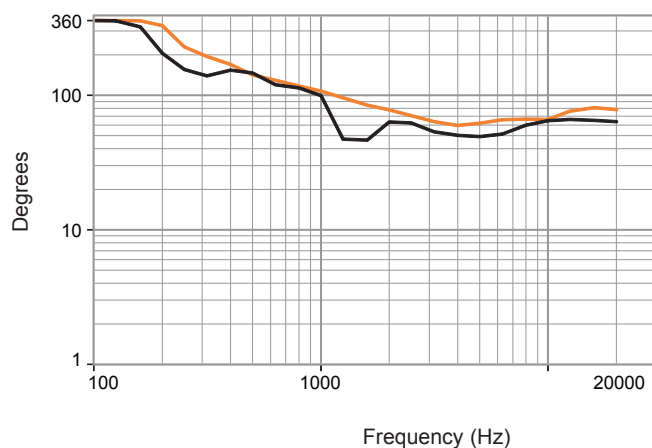

MK2364i Specifications

HORIZONTAL POLAR DATA

See *NOTES GRAPHIC DATA* for details

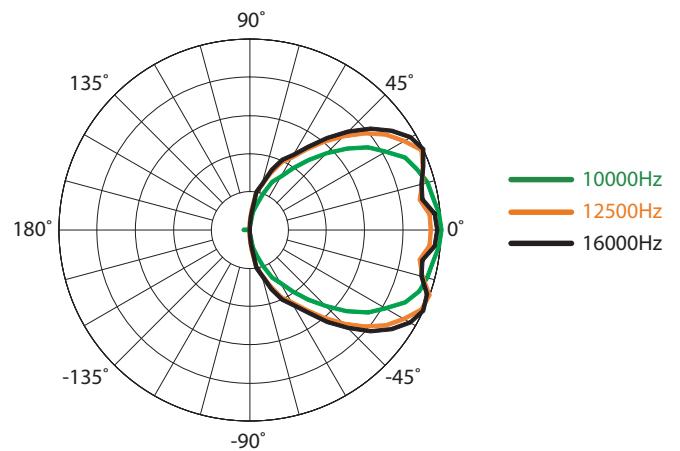
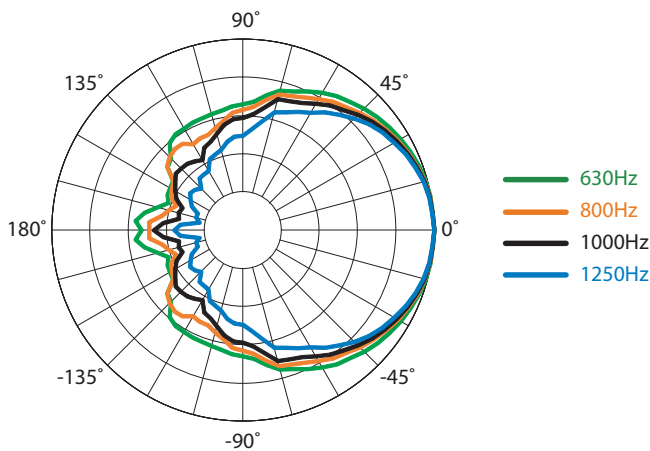
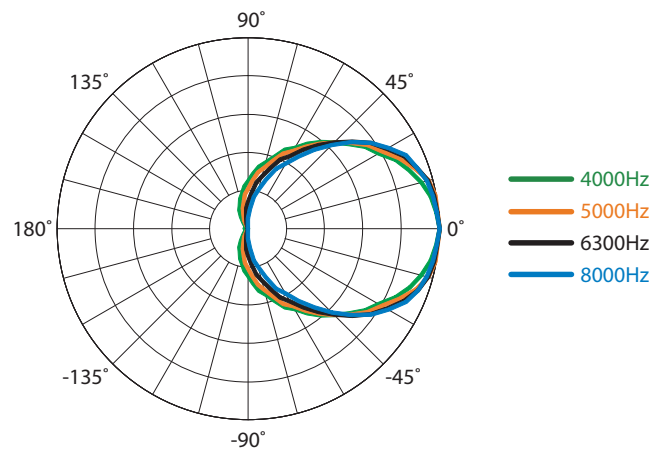
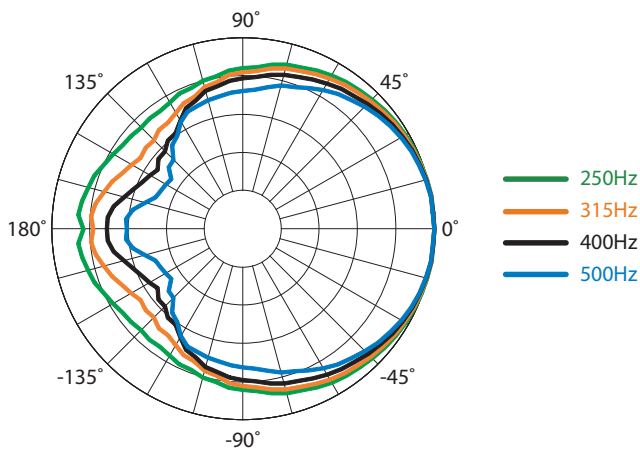
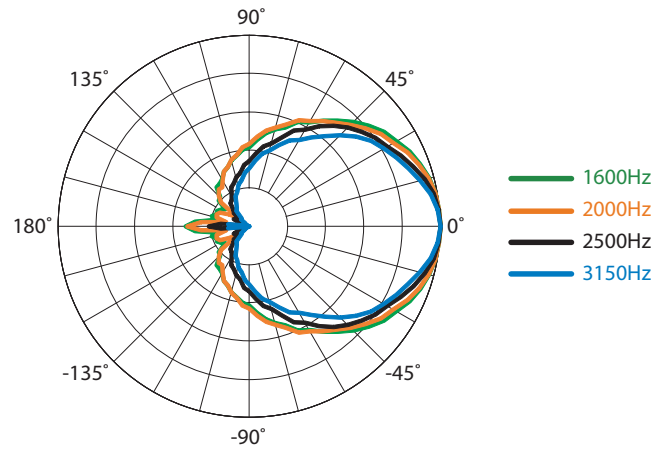
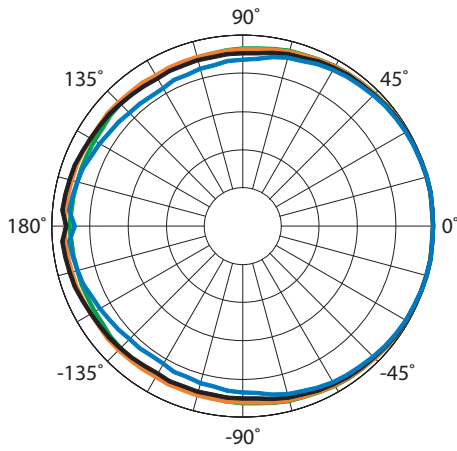

MK2364i Specifications

VERTICAL POLAR DATA

See *NOTES GRAPHIC DATA* for details

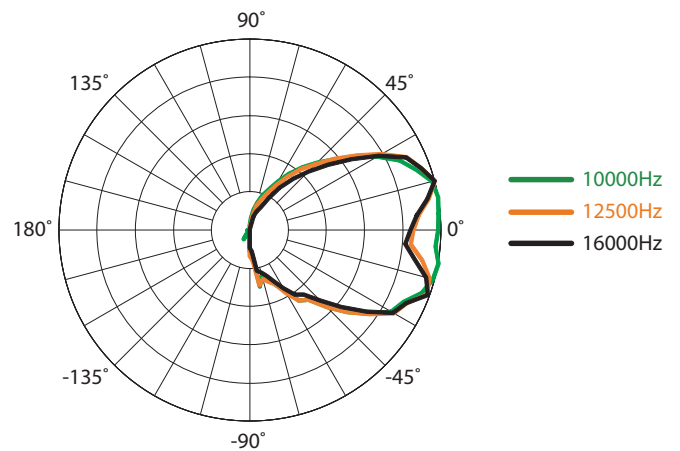
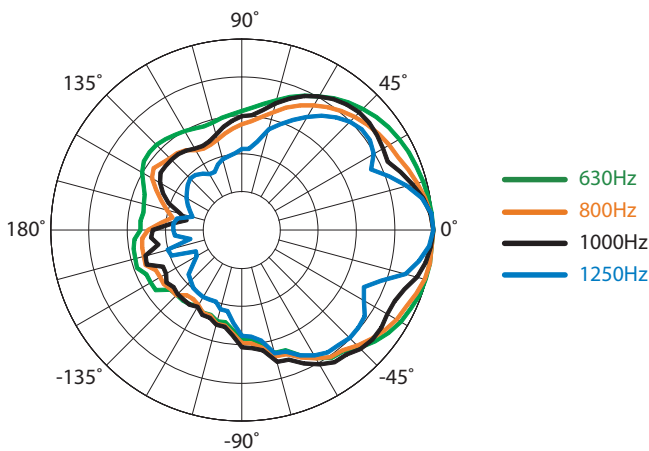
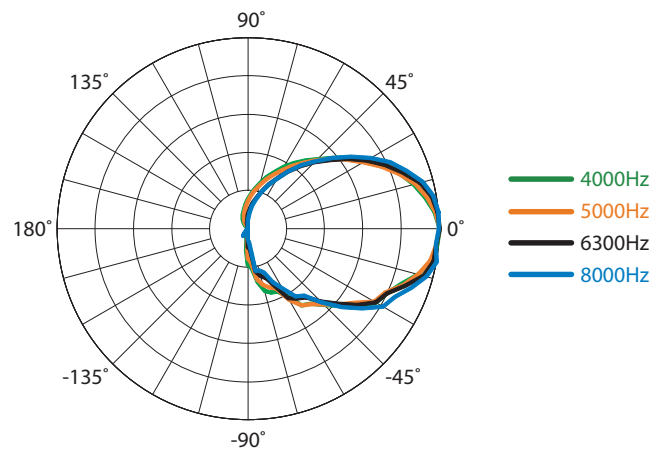
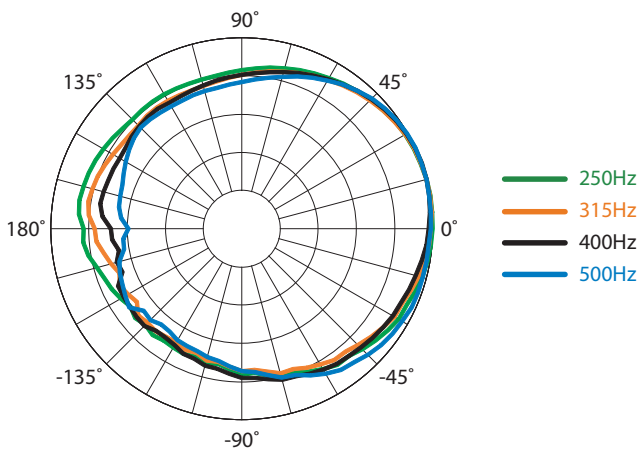
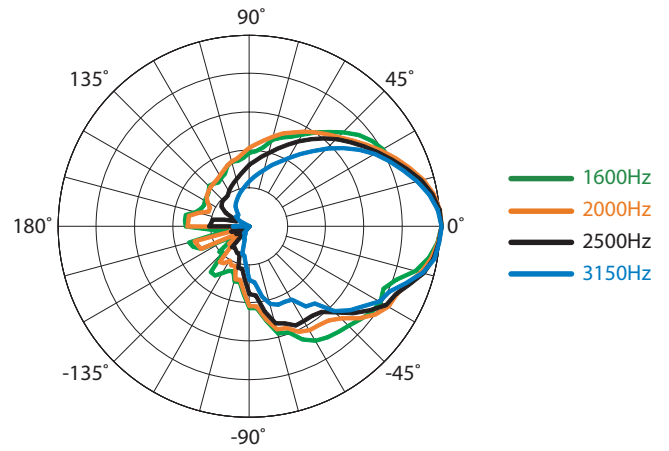
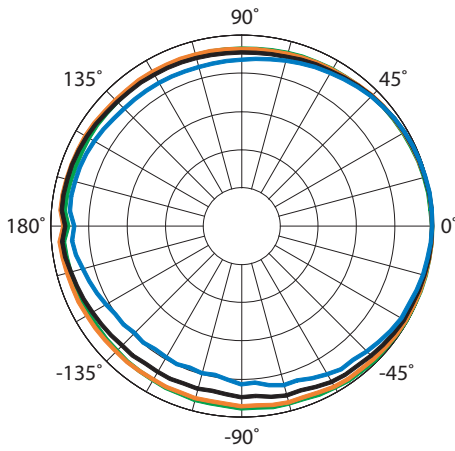

MK2364i Specifications

INPUT PANEL

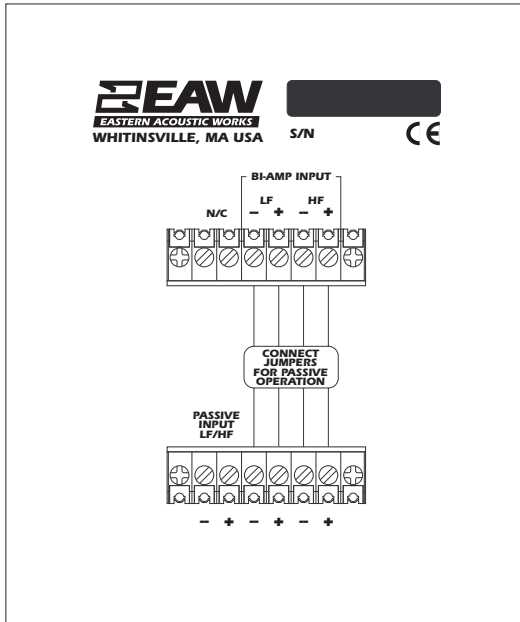

SIGNAL DIAGRAM

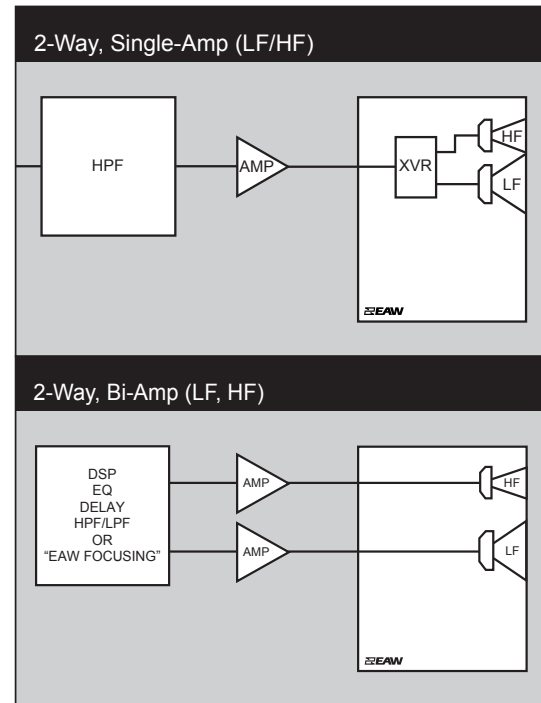

LEGEND

- HPF:** High Pass Filter for crossover –or– Recommended High Pass Filter.
- LPF:** Low Pass Filter for crossover.
- LF/MF/HF:** Low Frequency / Mid Frequency / High Frequency.
- AMP:** User Supplied Power Amplifier –or– Integral Amplifier for NT products.
- XVR:** Passive LPFs, HPFs, and EQ integral to the loudspeaker.
- EAW Focusing:** Digital Signal Processor capable of implementing EAW Focusing.

NOTES

TABULAR DATA

1. **Measurement/Data Processing Systems:** Primary - FChart: proprietary EAW software; Secondary - Brüel & Kjær 2012.
2. **Microphone Systems:** Earthworks M30; Brüel & Kjær 4133
3. **Measurements:** Dual channel FFT; length: 32 768 samples; sample rate: 48 kHz; logarithmic sine wave sweep.
4. **Measurement System Qualification** (includes all uncertainties): SPL: accuracy +/-0.2 dB @ 1 kHz, precision +/-0.5 dB 20 Hz to 20 kHz, resolution 0.05 dB; Frequency: accuracy +/-1 %, precision +/-0.1 Hz, resolution the larger of 1.5 Hz or 1/48 octave; Time: accuracy +/-10.4 µs, precision +/-0.5 µs, resolution 10.4 µs; Angular: accuracy +/-1°, precision +/-0.5°, resolution 0.5°.
5. **Environment:** Measurements time-windowed and processed to eliminate room effects, approximating an anechoic environment. Data processed as anechoic or fractional space, as noted.
6. **Measurement Distance:** 7.46 m. Acoustic responses represent complex summation of the subsystems at 20 m. SPL is referenced to other distances using the Inverse Square Law.
7. **Enclosure Orientation:** For beamwidth and polar specifications, as shown in Mechanical Specification drawing.
8. **Volts:** Measured rms value of the test signal.
9. **Watts:** Per audio industry practice, "loudspeaker watts" are calculated as voltage squared divided by rated nominal impedance. Thus, these are not True Watt units of energy as defined by International Standard.
10. **SPL:** (Sound Pressure Level) Equivalent to the average level of a signal referenced to 0 dB SPL = 20 microPascals.
11. **Subsystem:** This lists the transducer(s) and their acoustic loading for each passband. Sub = Subwoofer, LF = Low Frequency, MF = Mid Frequency, HF = High Frequency.
12. **Operating Mode:** User selectable configurations. Between system elements, a comma (,) = separate amplifier channels; a slash (/) = single amplifier channel. DSP = Digital Signal Processor.
IMPORTANT: To achieve the specified performance, the listed external signal processing must be used with EAW-provided settings.
13. **Operating Range:** Range where the processed Frequency Response stays within -10 dB SPL of the power averaged SPL within this range; measured on the geometric axis. Narrow band dips are excepted.
14. **Nominal Beamwidth:** Design angle for the -6 dB SPL points, referenced to 0 dB SPL as the highest level.
15. **Axial Sensitivity:** Power averaged SPL over the Operating Range with an input voltage that would produce 1 W at the nominal impedance; measured with no external processing on the geometric axis, referenced to 1 m.
16. **Nominal Impedance:** Selected 4, 8, or 16 ohm resistance such that the minimum impedance point is no more than 20% below this resistance over the Operating Range.
17. **Accelerated Life Test:** Maximum test input voltage applied with an EIA-426B defined spectrum; measured with recommended signal processing and Recommended Protection Filter.
18. **Calculated Axial Output Limit:** Highest average and peak SPLs possible during the Accelerated Life Test. The Peak SPL represents the 2:1 (6 dB) crest factor of the Life Test signal.
19. **High Pass Filter:** This helps protect the loudspeaker from excessive input signal levels at frequencies below the Operating Range.

GRAPHIC DATA

1. **Resolution:** To remove insignificant fine details, 1/12 octave cepstral smoothing was applied to acoustic frequency responses and 1/3 octave cepstral smoothing was applied to the beamwidth and impedance data. Other graphs are plotted using raw data.
2. **Frequency Responses:** Variation in acoustic output level with frequency for a constant input signal. Processed: normalized to 0 dB SPL. Unprocessed inputs: 2 V (4 ohm nominal impedance), 2.83 V (8 ohm nominal impedance), or 4 V (16 ohm nominal impedance) referenced to a distance of 1 m.
3. **Processor Response:** The variation in output level with frequency for a constant input signal of 0.775 V = 0 dB reference.
4. **Beamwidth:** Average angle for each 1/3 octave frequency band where, starting from the rear of the loudspeaker, the output first reaches -6 dB SPL referenced to 0 dB SPL as the highest level. This method means the output may drop below -6 dB SPL within the beamwidth angle.
5. **Impedance:** Variation in impedance magnitude, in ohms, with frequency without regard to voltage/current phase. This means the impedance values may not be used to calculate True Watts (see 9 above).
6. **Polar Data:** Horizontal and vertical polar responses for each 1/3 octave frequency band 100 Hz to 16 kHz or Operating Range.