



## FEATURES

- Highly coherent coaxial design (12-inch LF)
- Enhanced fidelity and power handling
- Upgraded transducers and crossover design
- Switchable single-amp/bi-amp modes
- Convenient input connector location

## DESCRIPTION

The MicroWedge MW12 is a collaboration between original MicroWedge Series inventor Dave "Rat" Levine (owner of Rat Sound Systems, Inc.) and the EAW Engineering Department, resulting in dramatically upgraded performance and ergonomics. A 12-inch woofer is paired with a 3-inch voice coil HF compression driver on a horn that provides full yet controlled 90-degree horizontal dispersion. All frequencies emanate from the exact same point, eliminating crossover region problems and time/phase irregularities, as well as optimizing coherency. The coaxial approach also contributes to a very compact, low-profile footprint.

MicroWedge MW12 monitors are processor enhanced (rather than processor dependant) for true "plug and play" operation. User selectable single-amp and bi-amp modes are provided. The large port on the front of the cabinet enhances LF response in coupling with the floor, and this port houses both the carrying handle and the passive/active mode switch. The port also contains dual input connectors, keeping them concealed and protected, and allowing wedges to be placed as close together as desired. Additional cable can be stored in the port without impacting LF performance.

Rubber feet on the bottom of the enclosure reduce abrasion, and new integral rigging hardware – also mounted on the enclosure bottom – facilitates easy flying. The Baltic birch cabinets are protected with EAW's RoadCoat™ finish that's extremely durable, and the rugged steel grille keeps its distinctive shape even when stood upon. All components are highly liquid tolerant – virtually impervious to spilled drinks as well as natural elements like rain.

## 2-WAY FULL-RANGE STAGE MONITOR

See NOTES TABULAR DATA for details

### CONFIGURATION

#### Subsystem

	<b>Transducer</b>	<b>Loading</b>
LF	1x 12 in cone	Vented
HF	1x 1.4 in exit, 3 in voice coil compression driver	Horn-loaded

#### Operating Mode

	<b>Amplifier Channels</b>	<b>External Signal Processing</b>
Single-amp	LF/ HF	High pass filter
Bi-amp	LF, HF	DSP w/2-way filters

### PERFORMANCE <sup>1</sup>

<b>Operating Range</b>	64 Hz to 20 kHz	
<b>Nominal Beamwidth</b> ( <i>conical</i> )		
Horz	90°	
Vert	90°	
<b>Axial Sensitivity</b> ( <i>whole space SPL</i> )		
LF/HF	94 dB	64 Hz to 20 kHz
LF	95 dB	60 Hz to 930 Hz
HF	106 dB	730 Hz to 20 kHz

#### Input Impedance (*ohms*)

	<b>Nominal</b>	<b>Minimum</b>
LF/HF	8	6.4 @ 818 Hz
LF	8	7.9 @ 231 Hz
HF	8	8.7 @ 4732 Hz

#### High Pass Filter

High Pass =>50 Hz, 12 dB/octave Butterworth

#### Accelerated Life Test <sup>2</sup>

LF/HF	69 V	600 W @ 8 ohm
LF	69 V	600 W @ 8 ohm
HF	35 V	150 W @ 8 ohm

#### Calculated Axial Output Limit (*whole space SPL - 6dB Crest Factor*)

	<b>Average</b>	<b>Peak</b>
LF/HF	122 dB	128 dB
LF	123 dB	129 dB
HF	128 dB	134 dB

#### Max SPL (*whole space SPL - 12 dB Crest Factor*)

140 dB

### ORDERING DATA

<b>Description</b>	<b>Part Number</b>
MW12 2-Way Full Range Loudspeaker Black	0011736-90

<sup>1</sup> To achieve specified performance, the listed external signal processing with EAW-provided settings is required.

<sup>2</sup> For recommendations to select power amplifier size refer to: "HOW MUCH AMPLIFIER POWER DO I NEED?" on the EAW web site.

## ENCLOSURE

- Material Baltic birch plywood
- Finish RoadCoat™ wear resistant textured black paint
- Grille Powder-coated perforated steel

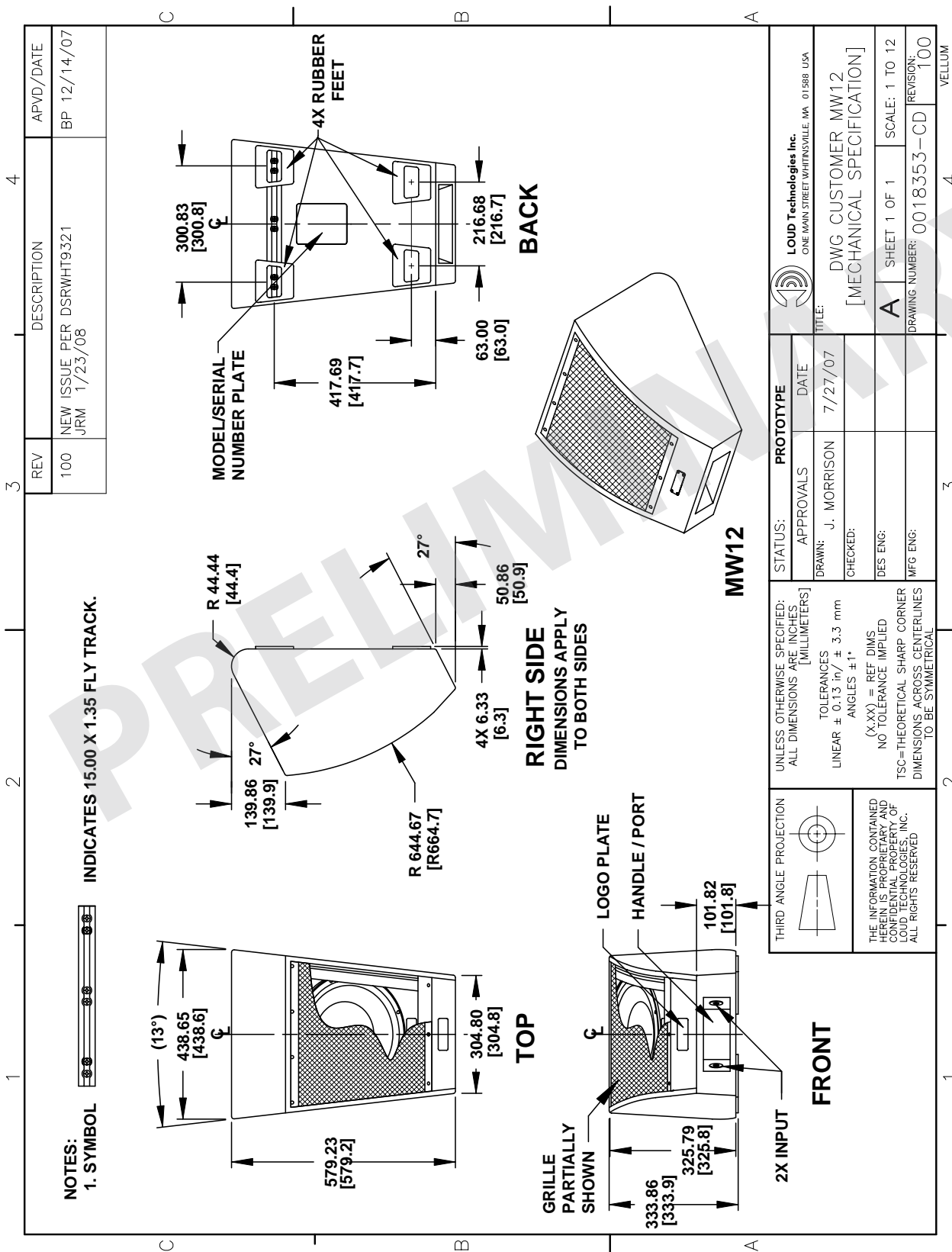

NOTE: This drawing has been reduced. Do not scale.

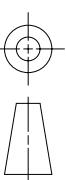
 <b>LOUD Technologies Inc.</b> ONE MAIN STREET WHITINSVILLE, MA 01588 USA	
STATUS: PROTOTYPE APPROVALS: J. MORRISON DRAWN: 7/27/07 CHECKED: DES ENG: MFG ENG:	DATE: 7/27/07 TITLE: DWG CUSTOMER MW12 [MECHANICAL SPECIFICATION]
UNLESS OTHERWISE SPECIFIED: ALL DIMENSIONS ARE INCHES [MILLIMETERS] TOLERANCES LINEAR ± 0.13 in / ± 3.3 mm ANGLES ± 1° (X.XX) = REF DIMS. NO TOLERANCE IMPLIED TSC=THEORETICAL SHARP CORNER DIMENSIONS ACROSS CENTERLINES TO BE SYMMETRICAL	
THIRD ANGLE PROJECTION  THE INFORMATION CONTAINED HEREIN IS PROPRIETARY AND CONFIDENTIAL PROPERTY OF LOUD TECHNOLOGIES, INC. ALL RIGHTS RESERVED	
SHEET 1 OF 1 SCALE: 1 TO 12 DRAWING NUMBER: 0018353-CD REVISION: 100 VELLUM	

## PERFORMANCE DATA

See **NOTES GRAPHIC DATA** for details

### Frequency Response: Processed Multi-amplified

LF = green, HF = black, Complete = blue

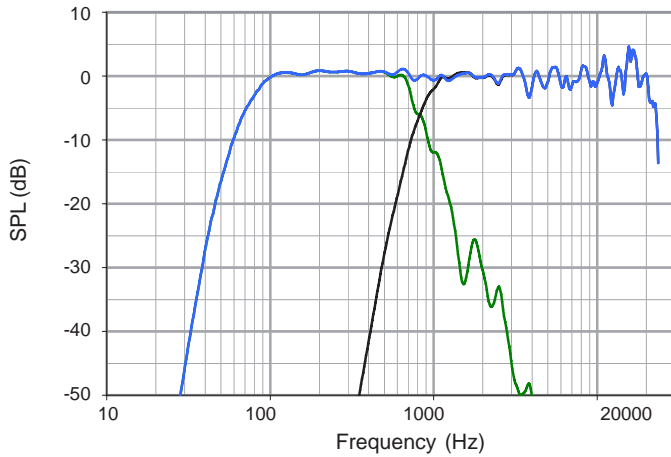

### Frequency Response: Unprocessed

LF = green, HF = black, Complete = blue

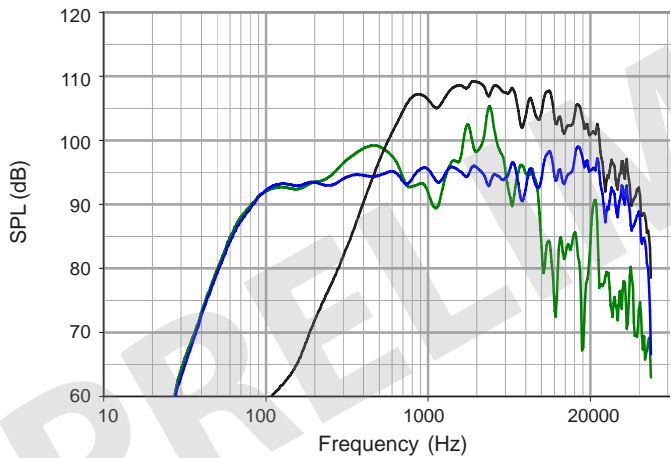

### Frequency Response: Digital Signal Processor

LF = green, HF = black

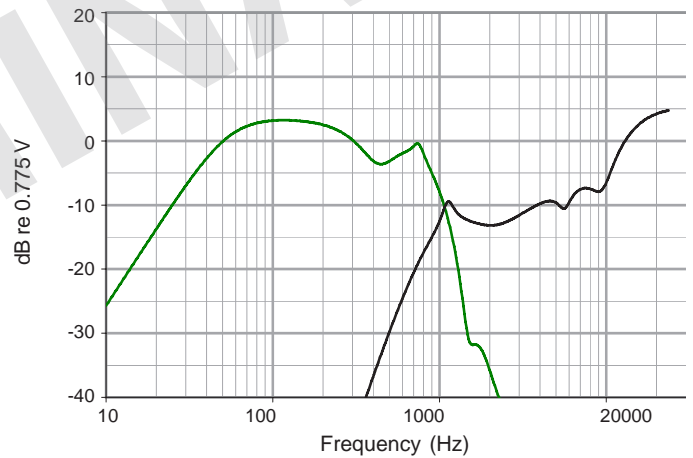

### Impedance Magnitude

LF = green, HF = black, Complete = blue

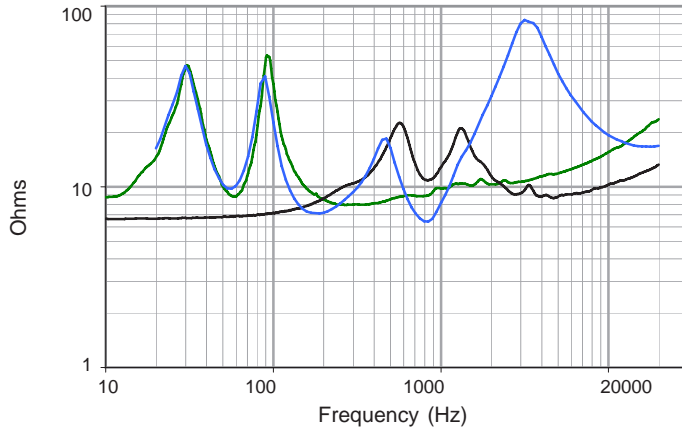

### Beamwidth (-6 dB SPL Points)

Horizontal = orange Vertical = black

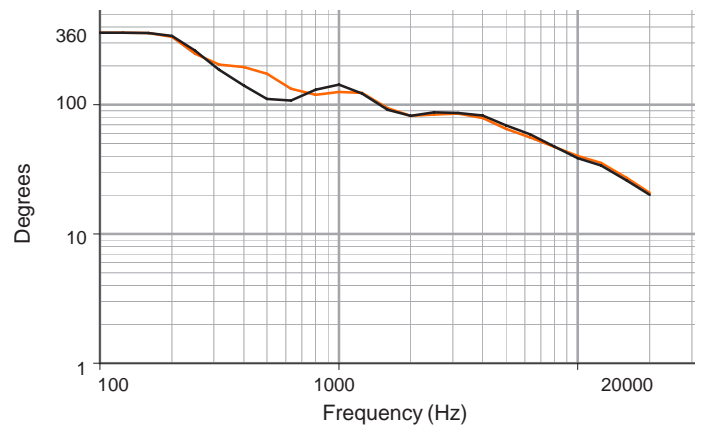

## HORIZONTAL POLAR DATA (Gridlines: 6 dB axial / 15 degree radial)

See **NOTES GRAPHIC DATA** for details

100 Hz  
125 Hz  
160 Hz  
200 Hz

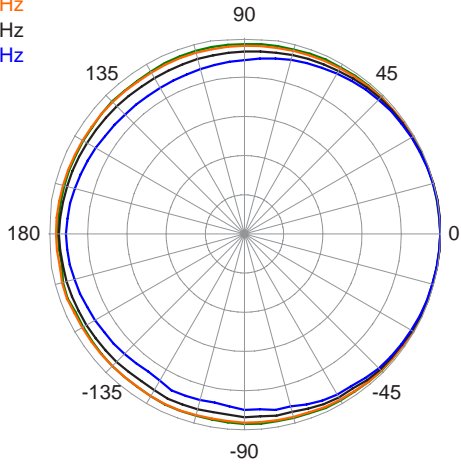

1600 Hz  
2000 Hz  
2500 Hz  
3150 Hz

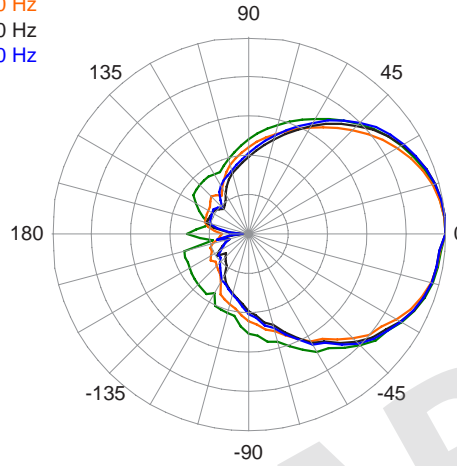

250 Hz  
315 Hz  
400 Hz  
500 Hz

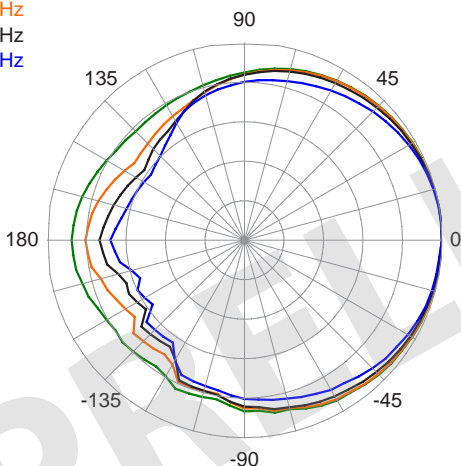

4000 Hz  
5000 Hz  
6300 Hz  
8000 Hz

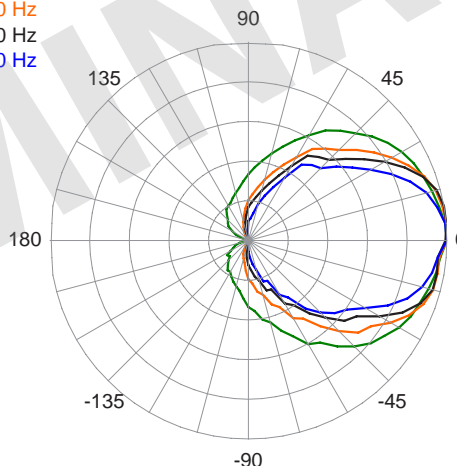

630 Hz  
800 Hz  
1000 Hz  
1250 Hz

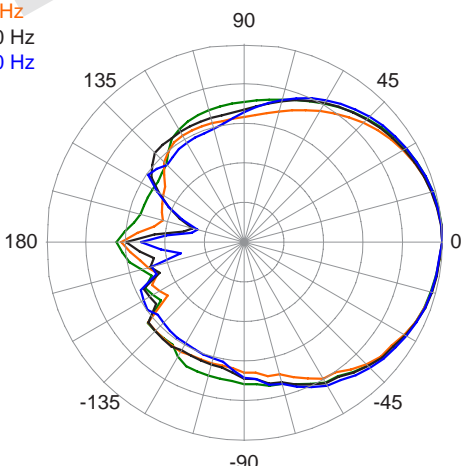

10000 Hz  
12500 Hz  
16000 Hz

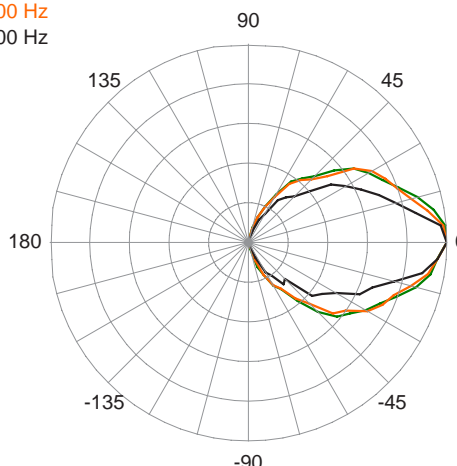

## VERTICAL POLAR DATA (Gridlines: 6 dB axial / 15 degree radial)

See **NOTES GRAPHIC DATA** for details

100 Hz  
125 Hz  
160 Hz  
200 Hz

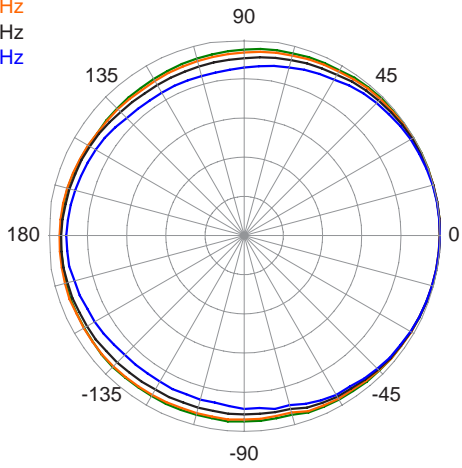

1600 Hz  
2000 Hz  
2500 Hz  
3150 Hz

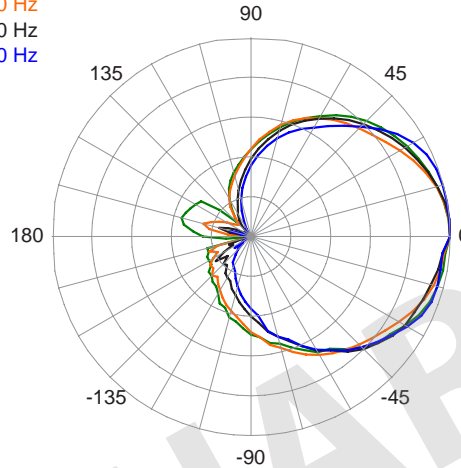

250 Hz  
315 Hz  
400 Hz  
500 Hz

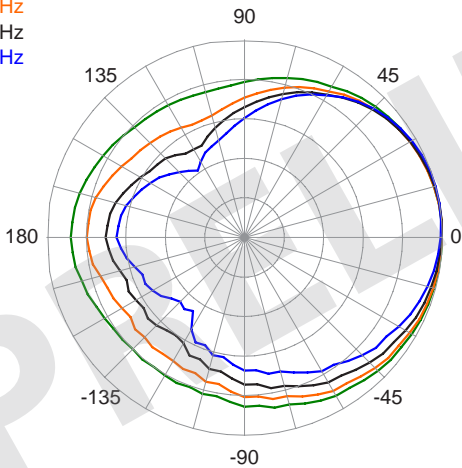

4000 Hz  
5000 Hz  
6300 Hz  
8000 Hz

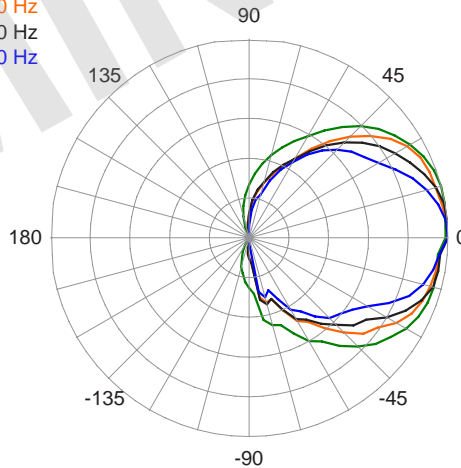

630 Hz  
800 Hz  
1000 Hz  
1250 Hz

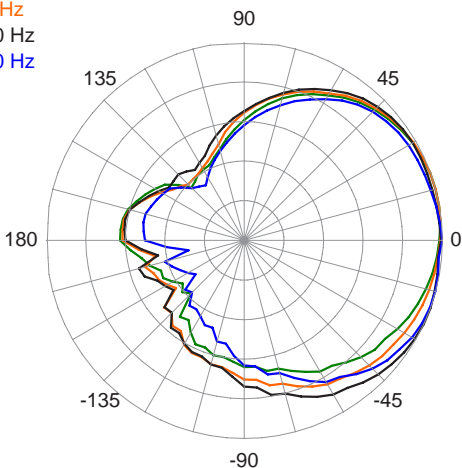

10000 Hz  
12500 Hz  
16000 Hz

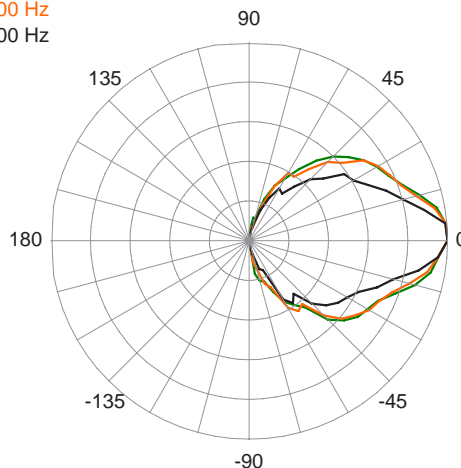

## INPUT PANEL

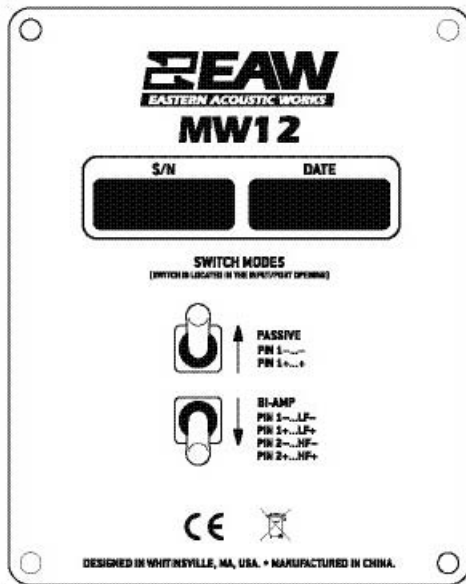

## SIGNAL DIAGRAM

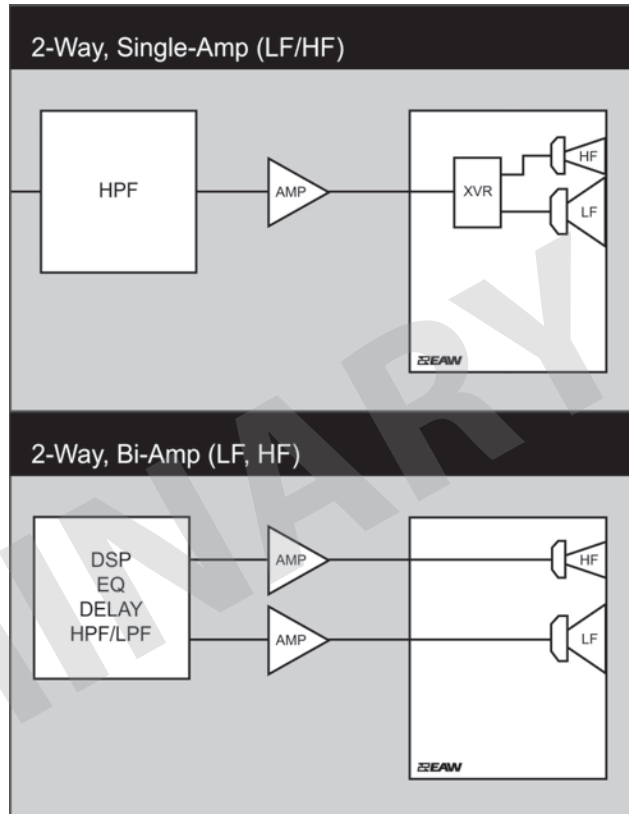

## LEGEND

- DSP:** User-supplied Digital Signal Processor.
- HPF:** High Pass Filter for crossover or Recommended High Pass Filter.
- LPF:** Low Pass Filter for crossover.
- LF/MF/HF:** Low Frequency / Mid Frequency / High Frequency.
- AMP:** User-supplied Power Amplifier.
- XVR:** Passive LPFs, HPFs, and EQ integral to the loudspeaker.

## NOTES

### TABULAR DATA

1. **Measurement/Data Processing Systems:** Primary - FChart: proprietary EAW software; Secondary - Brüel & Kjær 2012.
2. **Microphone Systems:** Earthworks M30; Brüel & Kjær 4133
3. **Measurements:** Dual channel FFT; length: 32 768 samples; sample rate: 48 kHz; logarithmic sine wave sweep.
4. **Measurement System Qualification** (includes all uncertainties): SPL: accuracy +/-0.2 dB @ 1 kHz, precision +/-0.5 dB 20 Hz to 20 kHz, resolution 0.05 dB; Frequency: accuracy +/-1 %, precision +/-0.1 Hz, resolution the larger of 1.5 Hz or 1/48 octave; Time: accuracy +/-10.4 µs, precision +/-0.5 µs, resolution 10.4 µs; Angular: accuracy +/-1°, precision +/-0.5°, resolution 0.5°.
5. **Environment:** Measurements time-windowed and processed to eliminate room effects, approximating an anechoic environment. Data processed as anechoic or fractional space, as noted.
6. **Measurement Distance:** 7.46 m. Acoustic responses represent complex summation of the subsystems at 20 m. SPL is referenced to other distances using the Inverse Square Law.
7. **Enclosure Orientation:** For beamwidth and polar specifications, as shown in Mechanical Specification drawing.
8. **Volts:** Measured rms value of the test signal.
9. **Watts:** Per audio industry practice, "loudspeaker watts" are calculated as voltage squared divided by rated nominal impedance. Thus, these are not True Watt units of energy as defined by International Standard.
10. **SPL:** (Sound Pressure Level) Equivalent to the average level of a signal referenced to 0 dB SPL = 20 microPascals.
11. **Subsystem:** This lists the transducer(s) and their acoustic loading for each passband. Sub = Subwoofer, LF = Low Frequency, MF = Mid Frequency, HF = High Frequency.
12. **Operating Mode:** User selectable configurations. Between system elements, a comma (,) = separate amplifier channels; a slash (/) = single amplifier channel. DSP = Digital Signal Processor. IMPORTANT: To achieve the specified performance, the listed external signal processing must be used with EAW-provided settings.
13. **Operating Range:** Range where the processed Frequency Response stays within -10 dB SPL of the power averaged SPL within this range; measured on the geometric axis. Narrow band dips are excepted.
14. **Nominal Beamwidth:** Design angle for the -6 dB SPL points, referenced to 0 dB SPL as the highest level.
15. **Axial Sensitivity:** Power averaged SPL over the Operating Range with an input voltage that would produce 1 W at the nominal impedance; measured with no external processing on the geometric axis, referenced to 1 m.
16. **Nominal Impedance:** Selected 4, 8, or 16 ohm resistance such that the minimum impedance point is no more than 20% below this resistance over the Operating Range.
17. **Accelerated Life Test:** Maximum test input voltage applied with an EIA-426B defined spectrum; measured with recommended signal processing and Recommended Protection Filter.
18. **Calculated Axial Output Limit:** Highest average and peak SPLs possible during the Accelerated Life Test. The Peak SPL represents the 2:1 (6 dB) crest factor of the Life Test signal.
19. **High Pass Filter:** This helps protect the loudspeaker from excessive input signal levels at frequencies below the Operating Range.

### GRAPHIC DATA

1. **Resolution:** To remove insignificant fine details, 1/12 octave cepstral smoothing was applied to acoustic frequency responses and 1/3 octave cepstral smoothing was applied to the beamwidth and impedance data. Other graphs are plotted using raw data.
2. **Frequency Responses:** Variation in acoustic output level with frequency for a constant input signal. Processed: normalized to 0 dB SPL. Unprocessed inputs: 2 V (4 ohm nominal impedance), 2.83 V (8 ohm nominal impedance), or 4 V (16 ohm nominal impedance) referenced to a distance of 1 m.
3. **Processor Response:** The variation in output level with frequency for a constant input signal of 0.775 V = 0 dB reference.
4. **Beamwidth:** Average angle for each 1/3 octave frequency band where, starting from the rear of the loudspeaker, the output first reaches -6 dB SPL referenced to 0 dB SPL as the highest level. This method means the output may drop below -6 dB SPL within the beamwidth angle.
5. **Impedance:** Variation in impedance magnitude, in ohms, with frequency without regard to voltage/current phase. This means the impedance values may not be used to calculate True Watts (see 9 above).
6. **Polar Data:** Horizontal and vertical polar responses for each 1/3 octave frequency band 100 Hz to 16 kHz or Operating Range.