

MKD1500 Series

2-Way Full-Range Loudspeakers

- ▶ High output bi-amplified two-way performance
- ▶ High performance coaxial compression driver with extended bandwidth
- ▶ Precision EAW signature broadband pattern control
- ▶ Flexible mounting, weather protection, color options

MKD1594
▶ 90° x 45°

MKD1564
▶ 60° x 45°

MKD1544
▶ 45° x 45°

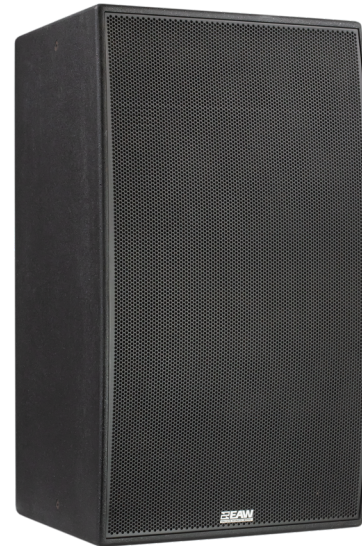

OVERVIEW

The MKD installation loudspeaker series is engineered to deliver the high output, broadband pattern control and exceptional fidelity that is required by real-world applications from stadiums to intimate music clubs.

MKD builds on EAW's long standing tradition of exceptional installation focused loudspeakers developed in partnership with consultants and sound system integrators worldwide. The compact durable Baltic birch enclosure provides for easy installation with an array of M10 mounting points. MKD also offers weather protection options, custom colors, and a gently curved front allow for concealed installations in the most visually sensitive environments.

MKD leverages the design tenets and core technologies deployed in our QX series by deploying a pair of spaced low frequency transducers centered around a large format rotatable horn.

INSIDE EAW TECHNOLOGIES

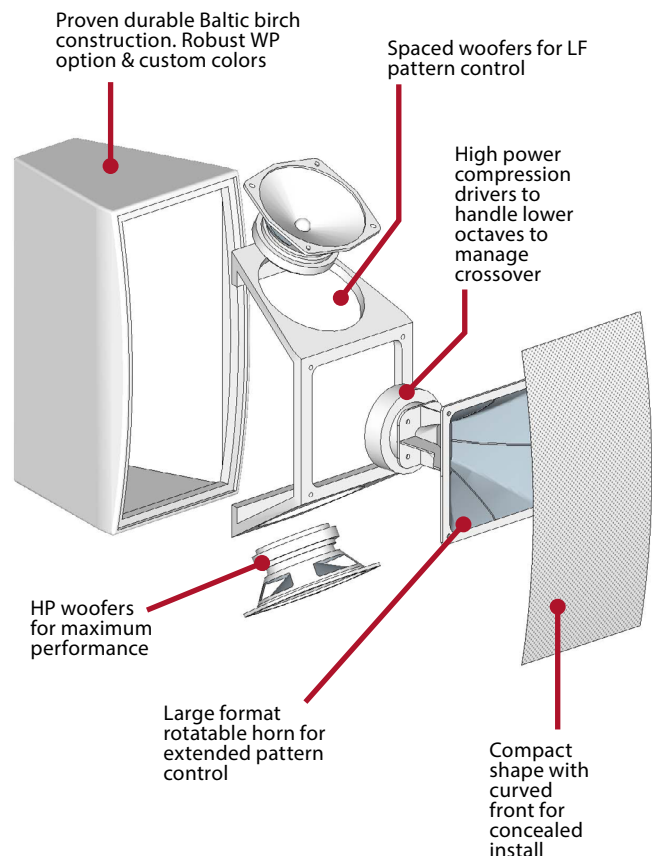

TECHNICAL SPECIFICATIONS

3-WAY FULL-RANGE LOUDSPEAKER

PERFORMANCE	MKD1544	MKD1564	MKD1594
Max SPL¹ (12 dB Crest Factor)	148dB	147dB	145dB
Max SPL¹ (6 dB Crest Factor)	142dB	141dB	139dB
Operating Range²	45Hz - 18kHz		
Nominal Beamwidth³	45° Horizontal x 45° Vertical	60° Horizontal x 45° Vertical	90° Horizontal x 45° Vertical
Nominal Phase	±15° from ideal high-pass filter		
Input Impedance	LF=4Ω MF/HF=8Ω		
ACCELERATED LIFE TEST⁴			
LF	1600W @ 4ohms		
MF/HF	250W @ 8ohms		
CONFIGURATION			
LF Transducer, Loading	2 x 15in Cone, 4in Voice Coil		
MF Transducer, Loading	1 x 2in Exit, 4in Voice Coil, Compression Midrange, Horn Loaded		
HF Transducer, Loading	1 x 2in Exit, 2.5in Voice Coil, Compression driver, Horn Loaded		
Operating Modes	Bi-Amp		
PHYSICAL			
Physical Rigging	12 x M10 Mounting Points		
Dimensions (HxWxD)	37H x 23W x 24D (935mm x 580mm x 600mm)		
Net Weight	130lbs (59kg)		
Shipping Weight	155lbs (70.5kg)		
Mounting Accessories	M10 Eyebolt		
Input Connector	Terminal block		

1 Calculated max SPL at 1m with 4:1pink noise. Specified as whole space (free field) for full range loudspeakers, half space for subwoofers.
 2 Operating Range: Range where the processed Frequency Response stays within -10 dB SPL of the power averaged SPL within this range; measured on the geometric axis. Narrow band dips are excepted.
 3 Nominal Beamwidth: Design angle for the -6 dB SPL points, referenced to 0 dB SPL as the highest level.
 4 Accelerated Life Test: Maximum test input voltage applied with an EIA-426B defined spectrum; measured with recommended signal processing and Recommended Protection Filter.
 5. Whole space SPL

INPUT

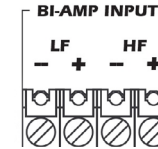

SIGNAL

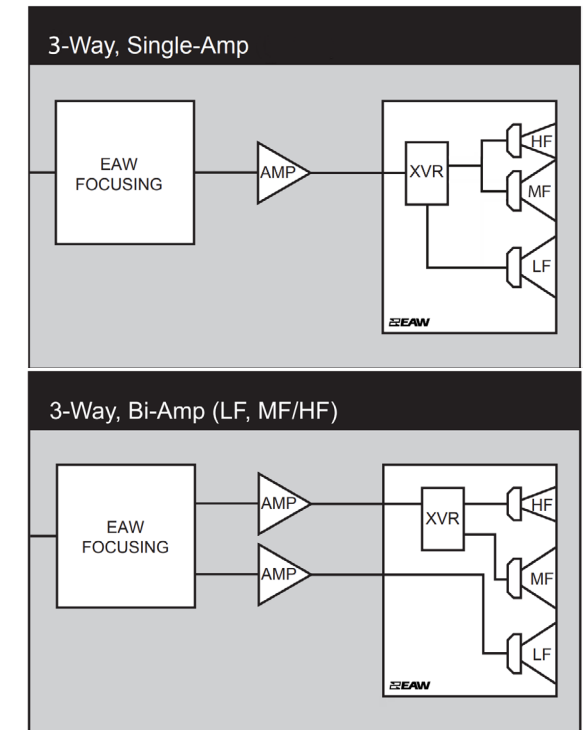

LEGEND

- LF/MF/HF:** Low Frequency / Mid Frequency / High Frequency.
- AMP:** User Supplied Power Amplifier –or– Integral Amplifier for NT products.
- XVR:** Passive LPFs, HPFs, and EQ integral to the loudspeaker.
- EAW Focusing:** Digital Signal Processor capable of implementing EAW Focusing.

RECOMMENDED AMPLIFIER CONFIGURATION

BI-AMP

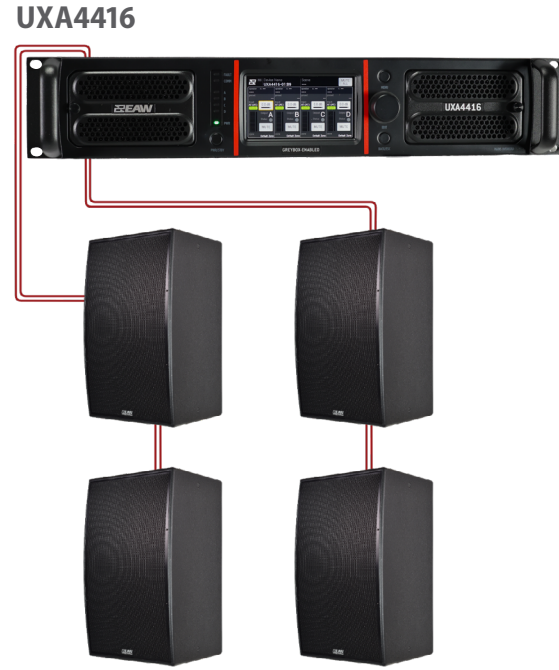

MODEL	PER CHANNEL	PER AMPLIFIER
UXA4416	2	4

EAW strongly recommends utilizing the processing setting to take full advantage of your speakers. Pair with EAW UXA Amps for the best performance of EAW Core Technologies

Third-Party DSP Support

- ▶ Powersoft
- ▶ QSYS

RIGGING CONFIGURATION

Numerous M10 points for flexible mounting



MOUNTING HARDWARE

EAW

DESCRIPTION	PART NUMBER
M10 Eyebolt	0029818

THIRD-PARTY COMPATIBLE

BRAND	MODEL
Polar Focus	QX Mounting System

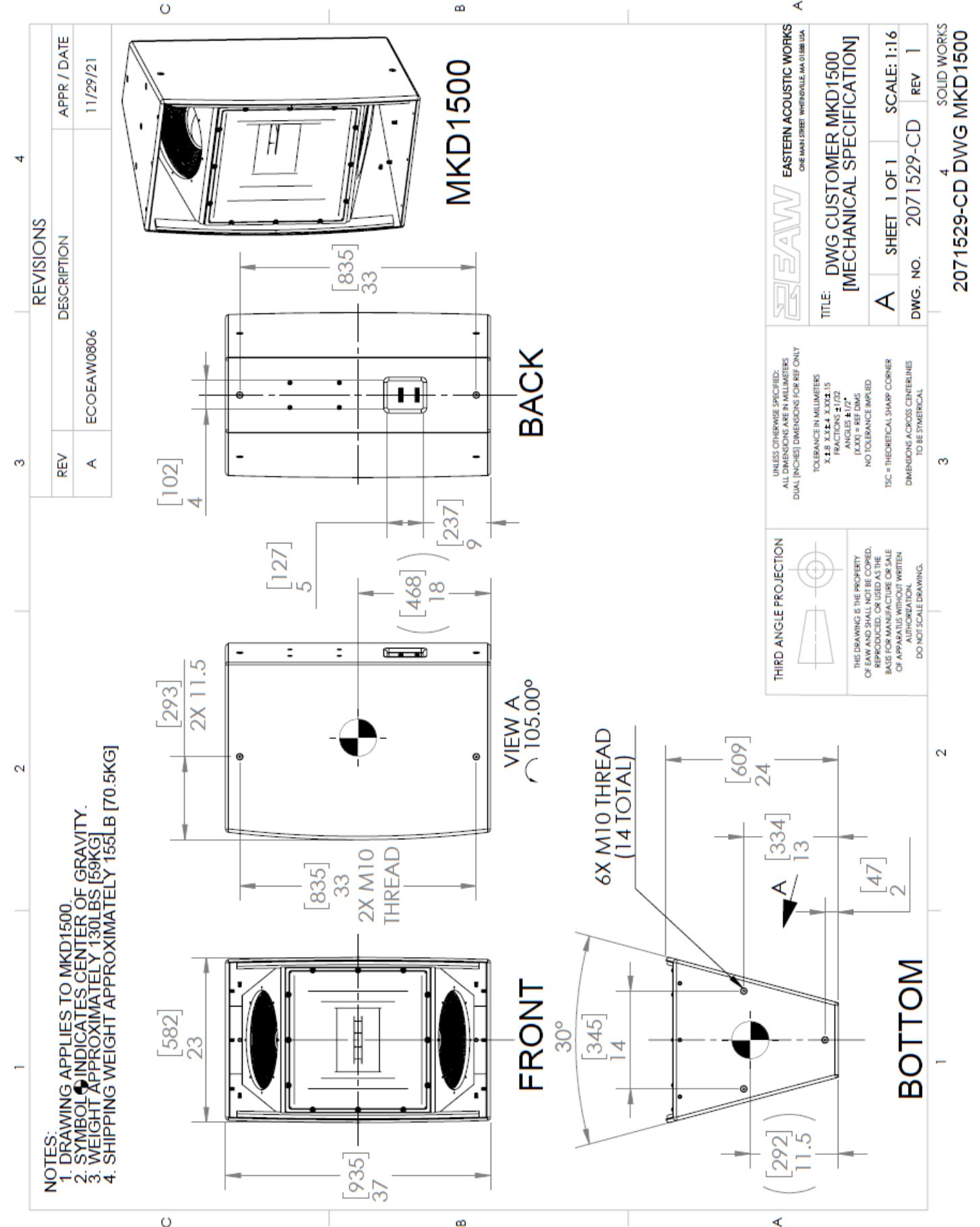

PERFORMANCE GRAPHS

PHASE LINEARITY

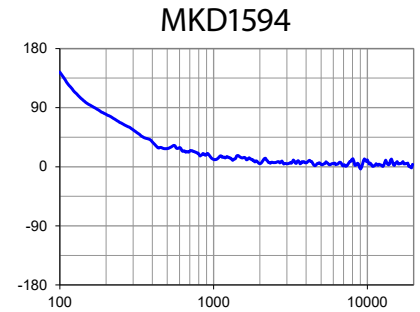
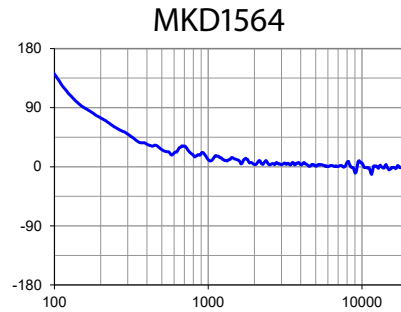
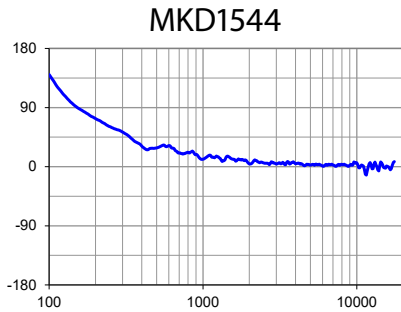

BEAMWIDTH¹ ■=Vertical ■=Horizontal

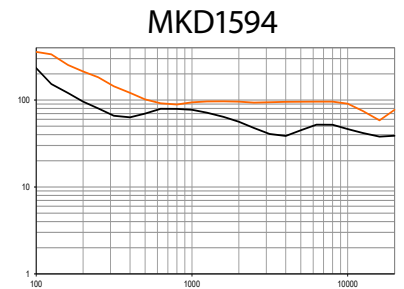
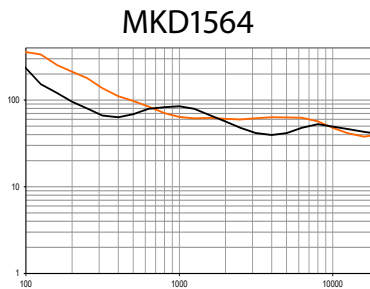
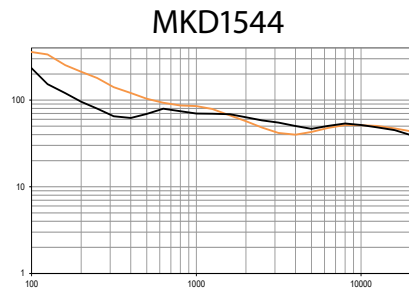

FREQUENCY² ■=LF Processed ■=HF Processed ■=Overall Response Processed

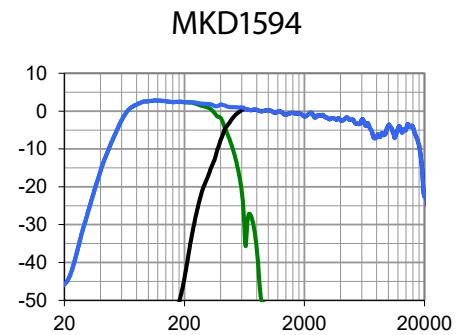
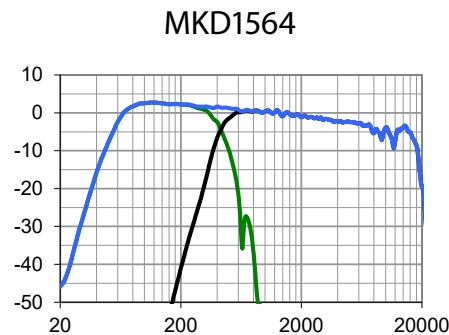
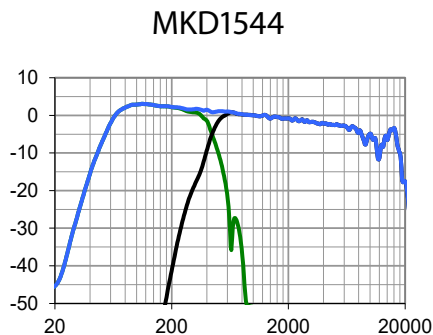

1 Average angle for each 1/3 octave frequency band where, starting from the rear of the loudspeaker, the output first reaches -6 dB SPL referenced to 0 dB SPL as the highest level. This method means the output may drop below -6 dB SPL within the beamwidth angle.

2 Variation in acoustic output level with frequency for a constant input signal. Processed: normalized to 0 dB SPL. Unprocessed inputs: 2 V (4 ohm nominal impedance), 2.83 V (8ohm nominal impedance), or 4 V (16 ohm nominal impedance) referenced to a distance of 1 m.